

# CONTENTS



CATEGORY	SUB CATEGORY	PAGE
<b>AX SERIES XLR CABLE CONNECTORS</b> <a href="#">PAGE 3</a>	METAL SHELL TYPE - SOLDER	3
<b>AC SERIES XLR CABLE CONNECTORS</b> <a href="#">PAGE 9</a>	METAL SHELL TYPE - SOLDER THERMOPLASTIC SHELL TYPE - SOLDER METAL SHELL TYPE RIGHT ANGLE - SOLDER METAL SHELL TYPE - IDC (SOLDERLESS) THERMOPLASTIC SHELL TYPE - IDC (SOLDERLESS)	10 14 15 16 18
<b>AC SERIES XLR METAL "Z" CHASSIS MOUNT CONNECTORS</b> <a href="#">PAGE 22</a>	METAL D - TYPE FLANGE - SOLDER AND PCB METAL P - TYPE FLANGE- - SOLDER AND PCB	23 26
<b>AC SERIES XLR PCB CHASSIS MOUNT CONNECTORS</b> <a href="#">PAGE 34</a>	THERMOPLASTIC A - TYPE FLANGE 3 CONTACT METAL B - TYPE FLANGE 3 CONTACT THERMOPLASTIC A - TYPE FLANGE 5 CONTACT	35 39 43
<b>AC SERIES DUAL 1/4" (6.35MM) / XLR</b> <a href="#">PAGE 50</a>	C - TYPE DUAL JACK / XLR CONNECTORS	51
<b>AC SERIES XLR THERMOPLASTIC CHASSIS MOUNT CONNECTORS</b> <a href="#">PAGE 57</a>	THERMOPLASTIC D - TYPE FLANGE THERMOPLASTIC P - TYPE FLANGE THERMOPLASTIC TYPE - IDC (SOLDERLESS)	58 60 62
<b>AC PDN SERIES</b> <a href="#">PAGE 71</a>	PDN TYPE	71
<b>EP/AP SERIES HIGH POWER CONNECTORS</b> <a href="#">PAGE 73</a>	EP METAL TYPE - SOLDER AP THERMOPLASTIC TYPE - SOLDER	74 76
<b>ACCESSORIES</b> <a href="#">PAGE 79</a>	ACCESSORIES	79
<b>RF CONNECTORS</b> <a href="#">PAGE 82</a>	BNC 75Ω CONNECTORS BNC PATCH PANELS	83 85
<b>1/4" PHONE CONNECTORS</b> <a href="#">PAGE 88</a>	1/4" (6.35mm) T-SERIES 1/4" (6.35mm) T-SERIES JUMBO 1/4" (6.35mm) MUSICIAN SERIES 1/4" (6.35mm) PHONE JACKS	89 91 94 96
<b>PLUGS AND SOCKETS</b> <a href="#">PAGE 102</a>	RCA SERIES G TYPE MINIATURE XLR	102 103
<b>MULTIPIN SERIES</b> <a href="#">PAGE 104</a>	MP-41 SERIES MP-62 / MP-65 SERIES	105 111
<b>CONNECTOR WIRING INFORMATION</b> <a href="#">PAGE 115</a>		115
<b>INDEX</b> <a href="#">PAGE 117</a>		117



## ISO VIEW OF AX SERIES XLR CABLE CONNECTOR

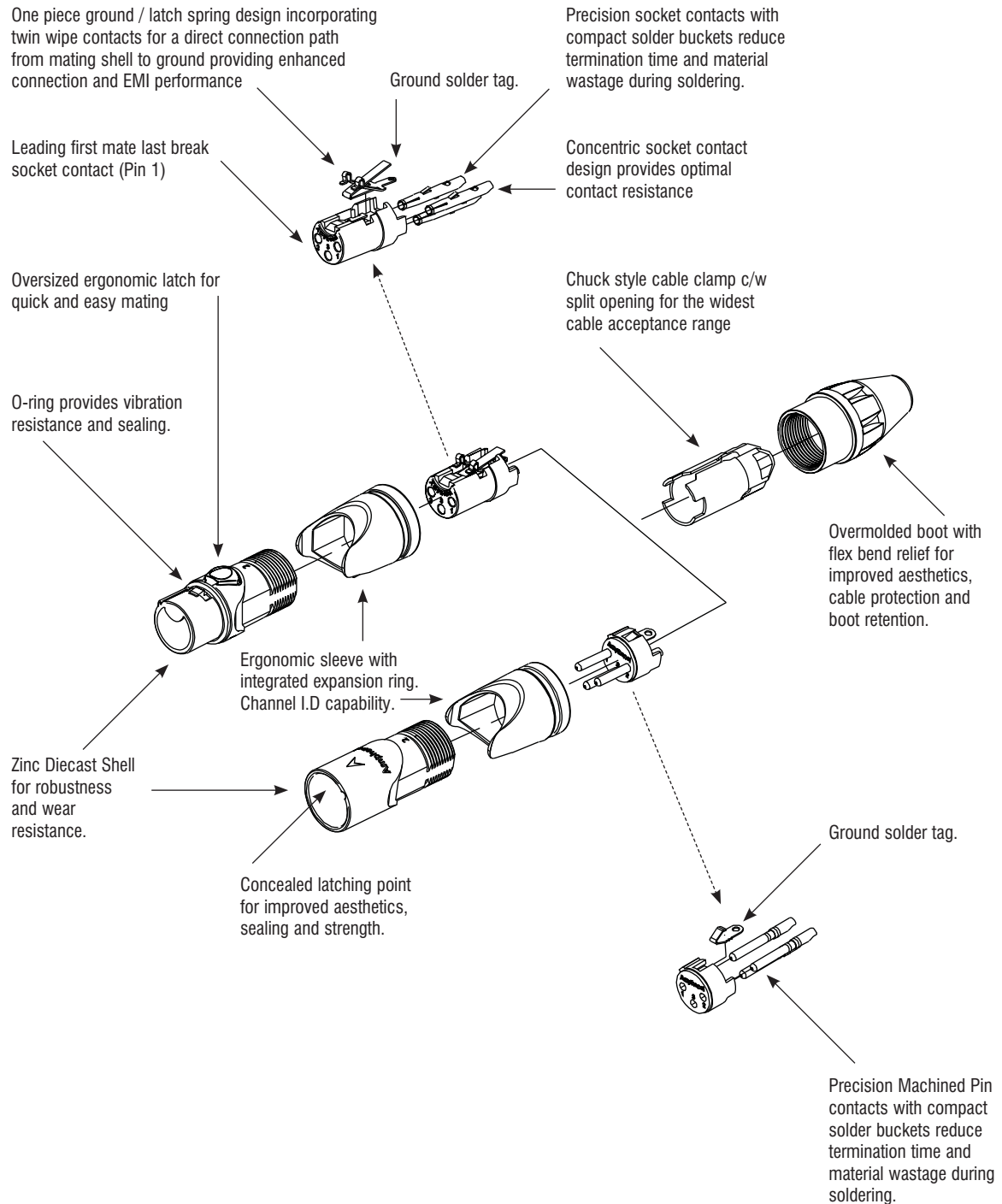



The revolutionary AX series of XLR connectors introduce an exciting contemporary look and feel to the professional audio interconnect market. They are designed to complement modern audio architecture and truly “fit” within their environment. An impressive list of features guarantees pure sound performance in the most demanding applications providing unrivalled value.

## Features

- Unique Australian designed shell and housing.
- One piece ground / latch spring design incorporating twin wipe contacts for a direct connection path from mating shell to ground providing enhanced connection and EMI performance.
- Ergonomic sleeve design for improved grip.
- Channel I.D capability with coloured or clear sleeves.
- Oversized ergonomic latch for quick and easy mating.
- Leading first mate last break pin 1 on socket connectors.
- Chuck style cable clamp to suit 3mm - 8mm (0.118" - 0.314") cable O.D. with integrated split to allow inclusion after soldering.
- Concealed latching point for improved aesthetics, sealing and strength.
- Overmolded boot with flex bend relief for improved aesthetics, cable protection and boot retention.
- Concentric socket contact design provides optimal contact resistance
- Precision machined pin contacts as standard.
- Compact 2.5mm<sup>2</sup> (14AWG) solder buckets to reduce termination time and material wastage during the soldering process.
- Zinc diecast shell housing for robustness and wear with Satin nickel or Black finish.

## Options

- Coloured I.D sleeves.
- Clear I.D Sleeve for connector marking.
- Satin nickel or Black shell finish.
- Single or Bulk packaging.
- Gold plated contacts.

## Ordering Codes

We have listed the more common ordering codes in each section. For further options please refer to the part number breakdown charts. Please contact us if you need any further assistance.

## AX SERIES XLR CABLE CONNECTORS



### Simple steps to guide you in using this catalogue

- 1) Identify the product group listed in Contents on Page 1 and go directly to that page number.
- 2) Each product group cover page then details information and options available.
- 3) Refer to the product detail pages and identify the product you require pictorially.
- 4) Read the product description column for the products standard features.
- 5) Use variations column to determine your choice.
- 6) Identify part number.
- 7) In the event the particular option you require is not listed please refer to the part number breakdown page at the end of each section.
- 8) Please contact us directly if you have any further problems.



**Features:**

- Unique Australian designed shell and housing.
- Ergonomic stylish sleeve design for improved grip.
- Oversized latch lever preserves your thumb.
- Leading first mate last break pin 1 on socket connectors.
- Chuck style cable clamp to suit 3mm - 8mm (0.118" - 0.314") cable O.D. with integrated split to allow inclusion after soldering.
- Overmolded cable support boot.
- New socket contact design for improved contact resistance.
- Precision machined pin contacts as standard.
- Compact 2.5mm<sup>2</sup> (14AWG) solder buckets to reduce soldering time and wastage.
- Zinc diecast shell housing with Satin nickel or Matt black finish.

**Options:**

- Coloured I.D sleeves.
- Clear I.D Sleeve for connector marking.
- Satin nickel or Matt black shell finish.
- Single or Bulk packaging.

**Part Number Breakdown: Page 5**

**Specifications: Page 6**

**Assembly Instructions: PI538\***

PRODUCT - FIGURE	DRAWING Dimensions in mm (inches)	DESCRIPTION	VARIATIONS	PART NUMBER
		XLR 3 pole male Machined contacts Nickel Finish	Standard Gold Plated Contacts Bulk Pack	AX3M AX3M-AU AX3M BULK
		XLR 3 pole male Machined contacts Black Finish	Standard Gold Plated Contacts Bulk Pack	AX3MB AX3MB-AU AX3MB BULK
		XLR 3 pole female Stamped contacts Nickel Finish	Standard Gold Plated Contacts Bulk Pack	AX3F AX3F-AU AX3F BULK
		XLR 3 pole female Stamped contacts Black Finish	Standard Gold Plated Contacts Bulk Pack	AX3FB AX3FB-AU AX3FB BULK

\*PI538 is available for download at [www.amphenol.com.au](http://www.amphenol.com.au)





## PART NUMBER BREAKDOWN

### METAL SHELL TYPE - SOLDER

E. G. **AX3MB2-AU BULK**  
**AX** (Series Prefix), **3** contacts, **M**ale, **B**lack Finish,  
**2** (Red Sleeve)- **AU** (Gold Plated Contacts), **BULK** Packaged.

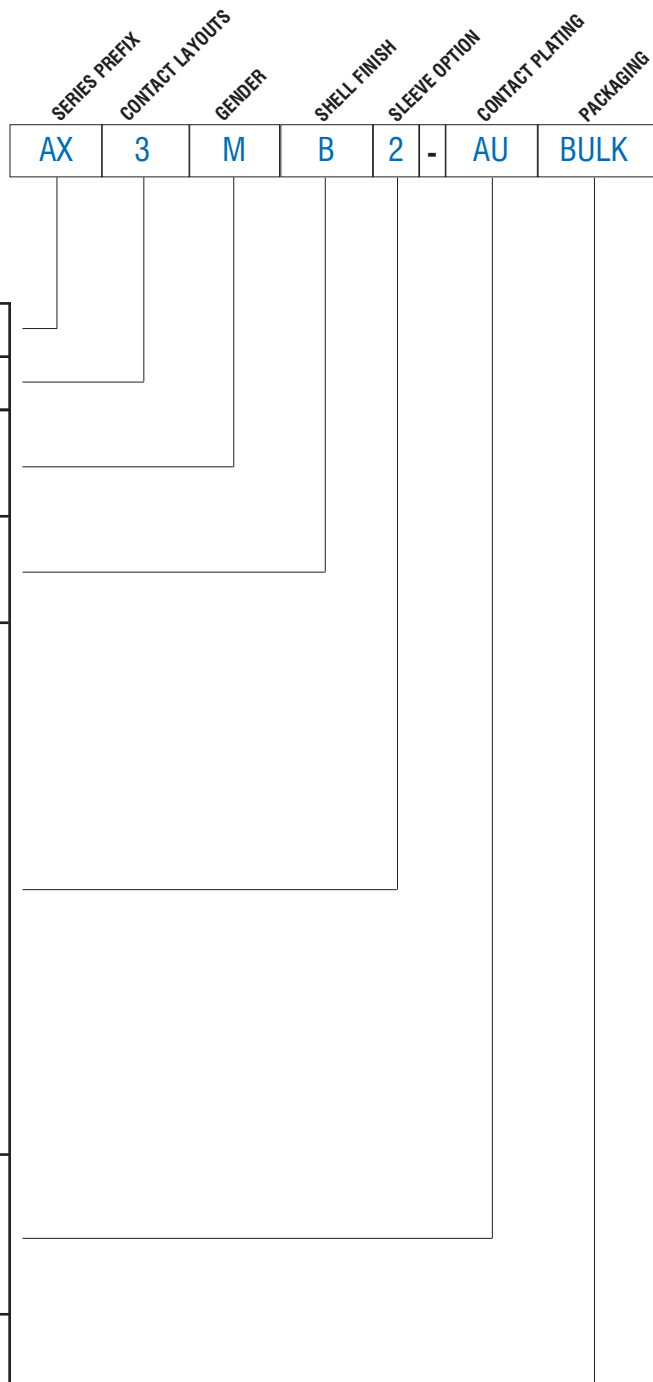

<b>SERIES PREFIX</b>	AX	=	Series Prefix
<b>CONTACT LAYOUTS</b>	3	=	3 Contacts
<b>GENDER</b>	F	=	Female Socket Contacts
	M	=	Male Pin Contacts
<b>SHELL FINISH</b>	Blank	=	Nickel Plated Finish
	B	=	Black Finish
<b>SLEEVE OPTION</b>	1	=	Brown
	2	=	Red
	3	=	Orange
	4	=	Yellow
	5	=	Green
	6	=	Blue
	7	=	Violet
	8	=	Grey
	9	=	White
	C	=	Clear
<b>CONTACT PLATING</b>	Blank	=	Standard Plating ( Silver or Tin - Refer to Standard Data.)
	AU	=	Gold Plated
<b>PACKAGING</b>	Blank	=	Individual Bags
	BULK	=	Bulk Packed

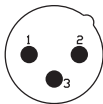

## STANDARD DATA AX SERIES CABLE CONNECTORS

		VALUE
<b>GENERAL CHARACTERISTICS</b>	Number of contacts	3
	AC Series Contact Arrangements (Front view of pin inserts)	
	Termination	SOLDER
	Max. Wire Gauge - Stranded wire:	
	Solder	14AWG
	Flammability rating of insulator plastics and housings	UL94V-0
	Environmental	Complies with RoHS Directive 2002/95/EC
<b>ELECTRICAL CHARACTERISTICS</b>	Service Voltage RMS	133V <sup>1)</sup>
	Test Voltage AC RMS	1400V
	Current carrying capacity:	
	Solder	15A
	Typical Contact Resistance	≤3m Ω
	Insulation Resistance	≥1G Ω
<b>CLIMATIC CHARACTERISTICS</b>	Protection Class	IP40
	Operating Temperature	-25°C to +75°C (-13°F to -167°F)
<b>MECHANICAL CHARACTERISTICS</b>	Insertion and Withdrawal force	≥10N - ≤30N
	Weight - Metal <sup>2)</sup>	36g (0.080lb)
	Typical Cable retention force	22Kg to 44Kg (50lb to 100lb) - Dependent on cable material and diameter.
	Cable O.D. range	3mm to 8mm (0.118" to 0.314")
	Mechanical Operations	1000 mating cycles

<sup>1)</sup> Not suitable for domestic applications above 50V

<sup>2)</sup> Approximate weight only, does not include packaging. Please contact us for exact weight for shipping purposes.



## STANDARD DATA AX SERIES CABLE CONNECTORS

		DETAILS
<b>MATERIALS</b>	Connector shell - Metal	Diecast Zinc Alloy
	Shell finish	Satin nickel or Black
	Insulators	UL94V-0 PA66, 30% Glass Filled
	Boot / Backshell	UL94V-0 Noryl N190 / Santoprene
	Finish	Black, other colours available - see page 80
	Cable clamp	Noryl N190
	Sleeve	Noryl N190
	Male Contact	
	Machined - Solder / Plating	Brass / Silver or Gold (Optional)
Female Contact		
Stamped - Solder / Plating	Phosphor Bronze / Tin or Gold (Optional)	

Rev 1 - 10/2008

# Amphenol

## ISO VIEW OF AC3MM

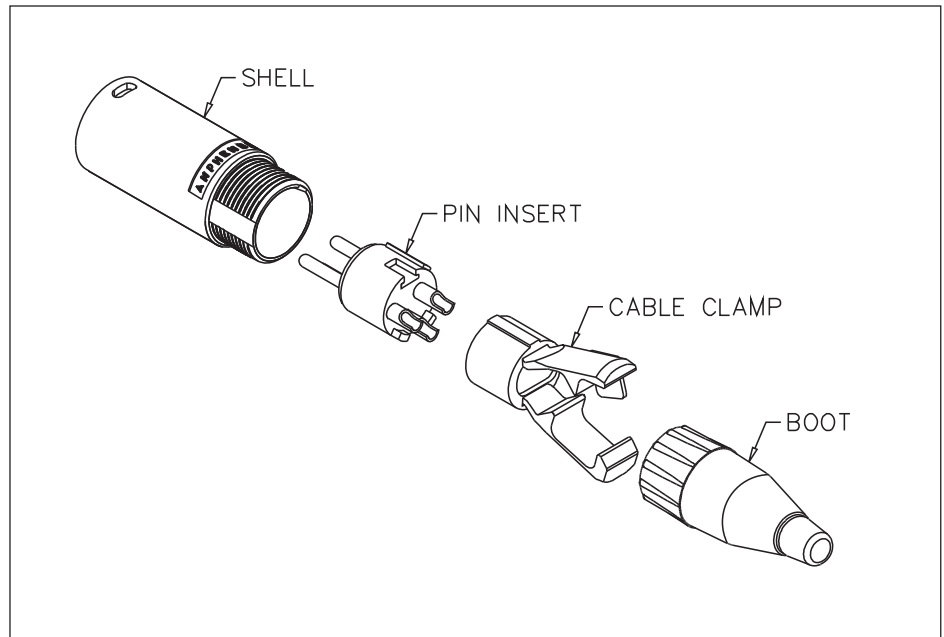

## ISO VIEW OF AC3FI

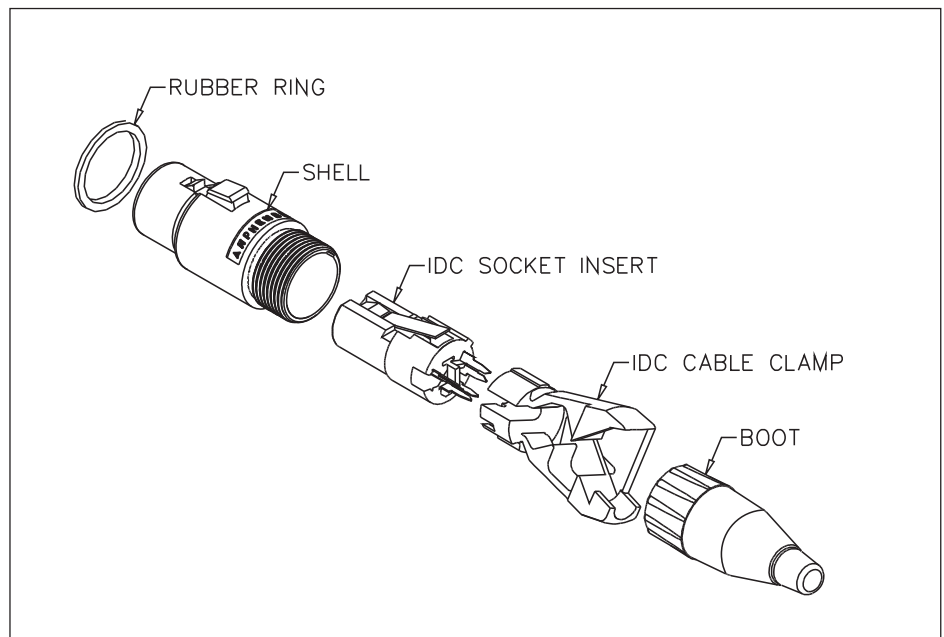

**AMPHENOL AUSTRALIA WEBSITE**

[www.amphenol.com.au](http://www.amphenol.com.au)

**AMPHENOL WORLD HEADQUARTERS WEBSITE**

[www.amphenol.com](http://www.amphenol.com)

# Amphenol



## AC SERIES XLR CABLE CONNECTORS



Amphenol Australia have been manufacturing and designing innovative XLR connectors since 1955 and were the first to offer the cost saving Insulation Displacement Contact (IDC) in an XLR connector. The IDC connector is ideal for Original Equipment Manufacturers and end users alike and offers an alternative to our standard solder connector. The AC series cable connector range complies with IEC268-12 and AES 14-1992 standards. CSA File Number 68598.

### Features

- AC series XLR connectors feature the unique Australian design and patented "Jaws" cable retention system for both standard Solder connectors and the Insulation Displacement Contact (IDC) connectors.
- A leading first mate last break socket contact is standard on all female connectors (Pin 1).
- The "Jaws" cable retention system provides up to 44kg (100lb) of strain.
- Solderless IDC technology offers savings of up to 60% in termination time.
- The AC series connector can be quickly and easily assembled without screws – by hand or portable termination tool. (Part number T2860)
- Available in 3, 4, 5, 6A and 7 contact arrangements.
- Compatible with all other XLR brands.

### Options

- Solder Bucket termination
- Insulation Displacement Contact (IDC)
- Thermoplastic shell
- Zinc Diecast shell - Satin Nickel Finish
- Zinc Diecast shell - Black Polyester Finish
- Gold, Silver or Tin Plated contacts
- Bulk Style Packaging
- Single Bag packs
- Precision machined contacts
- Cost effective stamped contacts on 3 pole

### Options (Cont'd)

- Standard Jaws cable clamp, Cable O.D 3mm to 6.5mm (0.118" to 0.255")
- Large Jaws cable clamp, Cable O.D 6.5mm to 8mm (0.255" to 0.314")
- IDC Jaws cable clamp, Max. Cable O.D 5.85mm (0.23")
- Metal Boots / Backshells
- Coloured Boots / Backshells
- Coloured Identification rings
- Termination / Assembly tooling

### Jaws Cable Clamp Options



Standard Jaws cable clamp (Black), Cable O.D 3mm to 6.5mm (0.118" to 0.255")



Large Jaws cable clamp (Purple), Cable O.D 6.5mm to 8mm (0.255" to 0.314")

### Ordering Codes

We have listed the more common ordering codes in each section. For further options please refer to the part number breakdown charts. Please contact us if you need any further assistance.

### Simple steps to guide you in using this catalogue

- 1) Identify the product group listed in Contents on Page 1 and go directly to that page number.
- 2) Each product group cover page then details information and options available.
- 3) Refer to the product detail pages and identify the product you require pictorially.
- 4) Read the product description column for the products standard features.
- 5) Use variations column to determine your choice.
- 6) Identify part number.
- 7) In the event the particular option you require is not listed please refer to the part number breakdown page at the end of each section.
- 8) Please contact us directly if you have any further problems.

# Amphenol











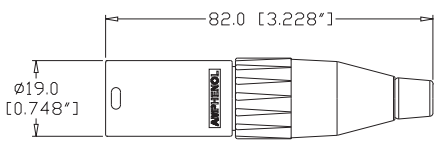

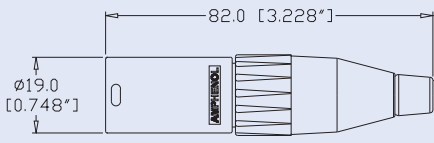
**Features:**

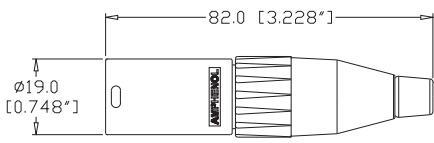
- Zinc Diecast Shell.
- Solder Bucket connections.
- "Jaws" Cable Retention System.
- Contact layouts in 3, 4, 5, 6A and 7.
- Precision machined or Stamped contacts.
- Leading first mate last break socket contact.
- Quick and easy assembly without screws – by hand or portable termination tool. (Part number T2860.)

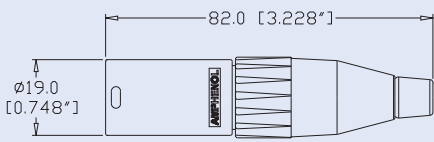
**Options:** Stamped Contacts (3 contact only), Gold plated contacts, Large or Small Jaws Cable Clamp, Black Finish Shell, Bulk Pack, Coloured Boots / Backshells

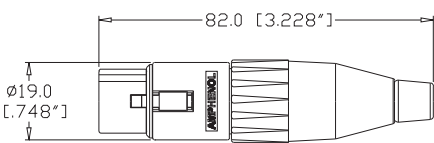

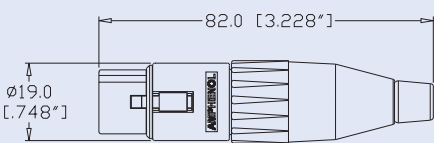





**Part Number Breakdown: Page 13**

**Specifications: Page 20-21**

PRODUCT - FIGURE	DRAWING	DESCRIPTION	VARIATIONS	PART NUMBER
	 <p>Dimensions in mm (inches)</p> <p>82.0 [3.228"]</p> <p>∅19.0 [0.748"]</p>	XLR 3 pole male, Machined contacts, Nickel Finish, Jaws cable clamp	<a href="#">Standard</a> <a href="#">Gold Plated Contacts</a> <a href="#">Large Cable Clamp</a> <a href="#">Bulk Pack</a>	<a href="#">AC3MM</a> <a href="#">AC3MM-AU</a> <a href="#">AC3MMJ</a> <a href="#">AC3MM BULK</a>
	 <p>Dimensions in mm (inches)</p> <p>82.0 [3.228"]</p> <p>∅19.0 [0.748"]</p>	XLR 3 pole male, Machined contacts, Black Finish, Jaws cable clamp	<a href="#">Standard</a> <a href="#">Gold Plated Contacts</a> <a href="#">Large Cable Clamp</a> <a href="#">Bulk Pack</a>	<a href="#">AC3MMB</a> <a href="#">AC3MMB-AU</a> <a href="#">AC3MMBJ</a> <a href="#">AC3MMB BULK</a>
	 <p>Dimensions in mm (inches)</p> <p>82.0 [3.228"]</p> <p>∅19.0 [0.748"]</p>	XLR 3 pole male, Stamped contacts, Nickel Finish, Jaws cable clamp	<a href="#">Standard</a> <a href="#">Gold Plated Contacts</a> <a href="#">Large Cable Clamp</a> <a href="#">Bulk Pack</a>	<a href="#">AC3M</a> <a href="#">AC3M-AU</a> <a href="#">AC3MJ</a> <a href="#">AC3M BULK</a>
	 <p>Dimensions in mm (inches)</p> <p>82.0 [3.228"]</p> <p>∅19.0 [0.748"]</p>	XLR 3 pole male, Stamped contacts, Black Finish, Jaws cable clamp	<a href="#">Standard</a> <a href="#">Gold Plated Contacts</a> <a href="#">Large Cable Clamp</a> <a href="#">Bulk Pack</a>	<a href="#">AC3MB</a> <a href="#">AC3MB-AU</a> <a href="#">AC3MBJ</a> <a href="#">AC3MB BULK</a>
	 <p>Dimensions in mm (inches)</p> <p>82.0 [3.228"]</p> <p>∅19.0 [0.748"]</p>	XLR 3 pole female, Stamped contacts, Nickel Finish, Jaws cable clamp	<a href="#">Standard</a> <a href="#">Gold Plated Contacts</a> <a href="#">Large Cable Clamp</a> <a href="#">Bulk Pack</a>	<a href="#">AC3F</a> <a href="#">AC3F-AU</a> <a href="#">AC3FJ</a> <a href="#">AC3F BULK</a>
	 <p>Dimensions in mm (inches)</p> <p>82.0 [3.228"]</p> <p>∅19.0 [0.748"]</p>	XLR 3 pole female, Stamped contacts, Black Finish, Jaws cable clamp	<a href="#">Standard</a> <a href="#">Gold Plated Contacts</a> <a href="#">Large Cable Clamp</a> <a href="#">Bulk Pack</a>	<a href="#">AC3FB</a> <a href="#">AC3FB-AU</a> <a href="#">AC3FBJ</a> <a href="#">AC3FB BULK</a>











# Amphenol

PRODUCT - FIGURE	DRAWING Dimensions in mm (inches)	DESCRIPTION	VARIATIONS	PART NUMBER
		XLR 4 pole male, Machined contacts, Nickel Finish, Jaws cable clamp	Standard	AC4M
			Gold Plated Contacts	AC4M-AU
			Large Cable Clamp	AC4MJ
			Bulk Pack	AC4M BULK
		XLR 4 pole male, Machined contacts, Black Finish, Jaws cable clamp	Standard	AC4MB
			Gold Plated Contacts	AC4MB-AU
			Large Cable Clamp	AC4MBJ
			Bulk Pack	AC4MB BULK
		XLR 4 pole female, Machined contacts, Nickel Finish, Jaws cable clamp	Standard	AC4F
			Gold Plated Contacts	AC4F-AU
			Large Cable Clamp	AC4FJ
			Bulk Pack	AC4F BULK
		XLR 4 pole female, Machined contacts, Black Finish, Jaws cable clamp	Standard	AC4FB
			Gold Plated Contacts	AC4FB-AU
			Large Cable Clamp	AC4FBJ
			Bulk Pack	AC4FB BULK
		XLR 5 pole male, Machined contacts, Nickel Finish, Jaws cable clamp	Standard	AC5M
			Gold Plated Contacts	AC5M-AU
			Large Cable Clamp	AC5MJ
			Bulk Pack	AC5M BULK
		XLR 5 pole male, Machined contacts, Black Finish, Jaws cable clamp	Standard	AC5MB
			Gold Plated Contacts	AC5MB-AU
			Large Cable Clamp	AC5MBJ
			Bulk Pack	AC5MB BULK
		XLR 5 pole female, Machined contacts, Nickel Finish, Jaws cable clamp	Standard	AC5F
			Gold Plated Contacts	AC5F-AU
			Large Cable Clamp	AC5FJ
			Bulk Pack	AC5F BULK
		XLR 5 pole female, Machined contacts, Black Finish, Jaws cable clamp	Standard	AC5FB
			Gold Plated Contacts	AC5FB-AU
			Large Cable Clamp	AC5FBJ
			Bulk Pack	AC5FB BULK



# Amphenol

PRODUCT - FIGURE	DRAWING Dimensions in mm (inches)	DESCRIPTION	VARIATIONS	PART NUMBER
		XLR 6A pole male, Machined contacts, Nickel Finish, Jaws cable clamp	Standard	AC6AM
			Gold Plated Contacts	AC6AM-AU
			Large Cable Clamp	AC6AMJ
			Bulk Pack	AC6AM BULK
		XLR 6A pole male, Machined contacts, Black Finish, Jaws cable clamp	Standard	AC6AMB
			Gold Plated Contacts	AC6AMB-AU
			Large Cable Clamp	AC6AMBJ
			Bulk Pack	AC6AMB BULK
		XLR 6A pole female, Machined contacts, Nickel Finish, Jaws cable clamp	Standard	AC6AF
			Gold Plated Contacts	AC6AF-AU
			Large Cable Clamp	AC6AFJ
			Bulk Pack	AC6AF BULK
		XLR 6A pole female, Machined contacts, Black Finish, Jaws cable clamp	Standard	AC6AFB
			Gold Plated Contacts	AC6AFB-AU
			Large Cable Clamp	AC6AFBJ
			Bulk Pack	AC6AFB BULK
		XLR 7 pole male, Gold plated Machined contacts, Nickel Finish, Jaws cable clamp	Standard	AC7M
			Large Cable Clamp	AC7MJ
			Bulk Pack	AC7M BULK
		XLR 7 pole male, Gold plated Machined contacts, Black Finish, Jaws cable clamp	Standard	AC7MB
			Large Cable Clamp	AC7MBJ
			Bulk Pack	AC7MB BULK
		XLR 7 pole female, Gold plated Machined contacts, Nickel Finish, Jaws cable clamp	Standard	AC7F
			Large Cable Clamp	AC7FJ
			Bulk Pack	AC7F BULK
		XLR 7 pole female, Gold plated Machined contacts, Black Finish, Jaws cable clamp	Standard	AC7FB
			Large Cable Clamp	AC7FBJ
			Bulk Pack	AC7FB BULK



# Amphenol

## PART NUMBER BREAKDOWN

### METAL SHELL TYPE - SOLDER



E. G. **AC3MMBJ-AU BULK**  
**AC** (Series Prefix), **3** contacts, **M**ale, **M**achined Contacts, **B**lack Polyester Finish,  
**J** (Large Jaws), - **AU** (Gold Plated Contacts), **BULK** Packaged.

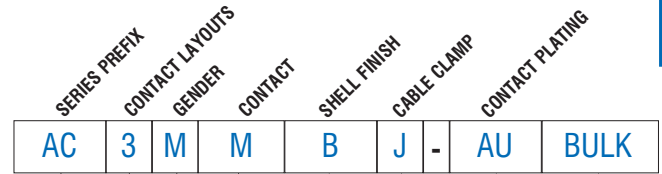

<b>SERIES PREFIX</b>	AC	=	Series Prefix
<b>CONTACT LAYOUTS</b>	3	=	3 Contacts
	4	=	4 Contacts
	5	=	5 Contacts
	6A	=	6 Contacts
	7	=	7 Contacts
<b>GENDER</b>	F	=	Female Socket Contacts
	M	=	Male Pin Contacts
<b>CONTACT</b>	Blank	=	Stamped Contacts
	M	=	Machined Contacts
	G	=	Stamped Contacts, Ground Tag
	MG	=	Machined Contacts, Ground Tag (Applicable 3 male pin contacts, option M and MG only)
NOTE: 4 - 7 contact connectors have machined contacts and grounding as standard. They are not available in stamped contacts.			
<b>SHELL FINISH</b>	Blank	=	Nickel Plated Finish
	B	=	Black Polyester Finish
<b>CABLE CLAMP</b>	Blank	=	Standard Jaws 3 mm - 6.5 mm cable O.D. (0.118" to 0.255")
	J	=	Large Jaws 6.5mm - 8mm cable O.D. (0.255" to 0.314")
<b>CONTACT PLATING</b>	Blank	=	Standard Plating ( Silver or Tin - Refer to Standard Data.)
	AU	=	Gold Plated
NOTE: 7 Contact is gold plated as standard.			
<b>PACKAGING</b>	Blank	=	Individual Bags
	BULK	=	Bulk Packed

**Note:** All AC Series Connectors are available with optional colour coded boot / backshell. Refer to page 80 and simply add colour to end of part number. Example: AC3MM - RED



**Features:**

- Thermoplastic Shell.
- Solder Bucket Connections.
- “Jaws” Cable Retention System.
- Stamped or Machined Contacts.
- Leading first mate last break socket contact.
- Quick and easy assembly without screws – by hand or portable termination tool. (Part number T2860.)

**Options:** Gold Plated Contacts, Stamped Contacts (3 Contact only), Bulk Pack, Coloured Boots / Backshells  
3, 4, 5, 6A and 7 Contacts.

**Specifications:** Page 20-21

PRODUCT - FIGURE	DRAWING Dimensions in mm (inches)	DESCRIPTION	VARIATIONS	PART NUMBER
		XLR 3 pole male, Machined contacts, Thermoplastic shell, Jaws cable clamp	Standard	AC3MMCP
			Gold Plated Contacts	AC3MMCP-AU
			Large Cable Clamp	AC3MMCPJ
			Bulk Pack	AC3MMCP BULK
		XLR 3 pole male, Stamped contacts, Thermoplastic shell, Jaws cable clamp	Standard	AC3MCP
			Gold Plated Contacts	AC3MCP-AU
			Large Cable Clamp	AC3MCPJ
			Bulk Pack	AC3MCP BULK
		XLR 3 pole female, Stamped contacts, Thermoplastic shell, Jaws cable clamp	Standard	AC3FCP
			Gold Plated Contacts	AC3FCP-AU
			Large Cable Clamp	AC3FCPJ
			Bulk Pack	AC3FCP BULK

**Note:** Thermoplastic shell connectors are also available in 4 - 7 contact arrangements, please contact us for ordering code.

**ISO VIEW OF AC3MM**

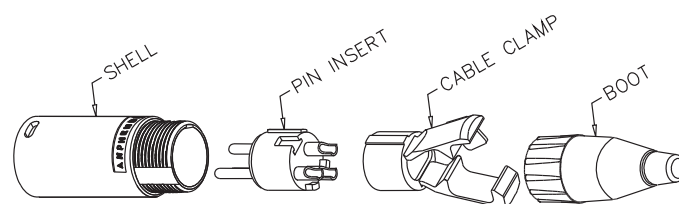



**Features:**

- XLR 90° right angle
- Metal or Thermoplastic connector shell
- Thermoplastic 90° right angle backshell
- Solder bucket connections
- "Jaws" Cable Retention System
- Contact Layouts in 3, 4, 5, 6A and 7
- Precision machined pin contacts
- Leading first mate last break socket contact

**Specifications: Page 20-21**

**Assembly Tooling: Page 79**



PRODUCT - FIGURE	DRAWING	DESCRIPTION	VARIATIONS	PART NUMBER
		XLR 90° right angle female, Metal shell, Nickel Finish, Jaws cable clamp	3 pole	AC3FR
			4 pole	AC4FR
			5 pole	AC5FR
			6A pole	AC6AFR
			7 pole	AC7FR
		XLR 90° right angle male, Metal shell, Nickel Finish, Jaws cable clamp	3 pole	AC3MMR
			4 pole	AC4MR
			5 pole	AC5MR
			6A pole	AC6AMR
			7 pole	AC7MR
		XLR 90° right angle female, Thermoplastic shell, Jaws cable clamp	3 pole	AC3FCPR
			4 pole	AC4FCPR
			5 pole	AC5FCPR
			6A pole	AC6AFCPR
			7 pole	AC7FCPR
		XLR 90° right angle male, Thermoplastic shell, Jaws cable clamp	3 pole	AC3MMCPR
			4 pole	AC4MCPR
			5 pole	AC5MCPR
			6A pole	AC6AMCPR
			7 pole	AC7MCPR



The Insulation Displacement Contact (IDC) connector is ideal for Original Equipment Manufacturers and end users alike and offers an alternative to our standard solder connector. Connectors can be quickly and easily assembled without screws or a soldering iron – by hand or portable termination tool. (Part number T2860.)

Labour savings of up to 60% in termination time can be achieved.

**Recommended Cable Dimensions: Page 21**

**Features:**

- Zinc Diecast Shell
- Available in 3 Contact only.
- Insulation Displacement Contacts (IDC - Solderless).
- “Jaws” Cable Retention System.
- Leading first mate last break socket contact.

**Options:** Gold plated contacts, Black Finish Shell, Bulk Pack, Coloured Boots / Backshells.

**Part Number Breakdown: Page 17 Specifications: Page 20-21 Assembly Instructions: Page 19**

PRODUCT - FIGURE	DRAWING	DESCRIPTION	VARIATIONS	PART NUMBER
		XLR 3 pole male, IDC contacts, Nickel Finish, IDC Jaws cable clamp	Standard	AC3MI
			Gold Plated Contacts	AC3MI-AU
			Bulk Pack	AC3MI BULK
		XLR 3 pole male, IDC contacts, Black Finish, IDC Jaws cable clamp	Standard	AC3MIB
			Gold Plated Contacts	AC3MIB-AU
			Bulk Pack	AC3MIB BULK
		XLR 3 pole female, IDC contacts, Nickel Finish, IDC Jaws cable clamp	Standard	AC3FI
			Gold Plated Contacts	AC3FI-AU
			Bulk Pack	AC3FI BULK
		XLR 3 pole female, IDC contacts, Black Finish, IDC Jaws cable clamp	Standard	AC3FIB
			Gold Plated Contacts	AC3FIB-AU
			Bulk Pack	AC3FIB BULK

**Note:** Amphenol can not guarantee the termination performance unless the recommended cable dimensions listed on page 21 are followed.

**ISO VIEW OF AC3FI**

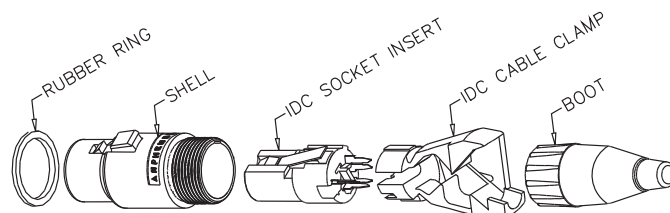



# Amphenol

## PART NUMBER BREAKDOWN

### METAL SHELL TYPE - IDC



E. G . **AC3MIB-AU BULK**  
**AC** (Series Prefix), **3** contacts, **M**ale, **IDC** Contacts, **B**lack Polyester Finish,  
 - **AU** (Gold Plated Contacts), **BULK** Packaged.

<b>SERIES PREFIX</b>	AC	=	Series Prefix
<b>CONTACT LAYOUT</b>	3	=	3 Contact only
<b>GENDER</b>	F	=	Female Socket Contacts
	M	=	Male Pin Contacts
<b>TERMINATION METHOD</b>	I	=	IDC Contacts
<b>SHELL FINISH</b>	Blank	=	Nickel Plated Finish
	B	=	Black Polyester Finish
<b>CONTACT PLATING</b>	Blank	=	Standard Plating (Silver or Tin - Refer to Standard Data.)
	AU	=	Gold Plated
<b>PACKAGING</b>	Blank	=	Individual Bags
	BULK	=	Bulk Packed

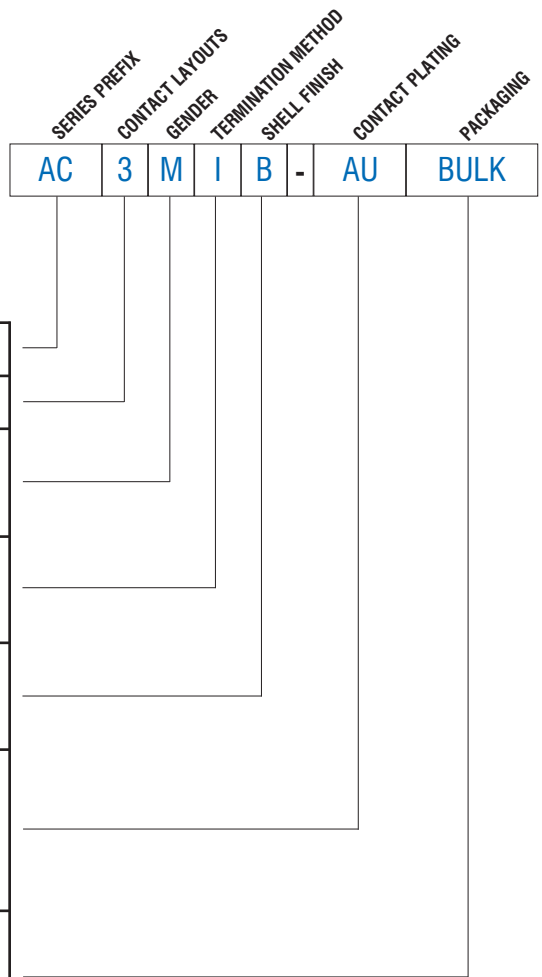

**Note:** All AC Series Connectors are available with optional colour coded boot / backshell. Refer to page 80 and simply add colour to end of part number. Example: AC3MI - RED





The Insulation Displacement Contact (IDC) connector is ideal for Original Equipment Manufacturers and end users alike and offers an alternative to our standard solder connector. Connectors can be quickly and easily assembled without screws or a soldering iron – by hand or portable termination tool. Labour savings of up to 60% in termination time can be achieved.

**Recommended Cable Dimensions: Page 21**

**Features:**

- Thermoplastic Shell
- Available 3 Contact only.
- Insulation Displacement Contacts (IDC - Solderless).
- "Jaws" Cable Retention System.
- Leading first mate last break socket contact.
- Quick and easy assembly without screws – by hand or portable termination tool. (Part number T2860.)

**Options:** Gold plated contacts, Bulk Pack, Coloured Boots / Backshells  
**Part Number Breakdown: Page 18** **Specifications: Page 20-21**  
**Assembly Instructions: Page 19**

PRODUCT - FIGURE	DRAWING Dimensions in mm (inches)	DESCRIPTION	VARIATIONS	PART NUMBER
		XLR 3 pole male, IDC contacts, Thermoplastic shell, IDC Jaws cable clamp	Standard	AC3MCPI
			Gold Plated Contacts	AC3MCPI-AU
			Bulk Pack	AC3MCPI-BULK
		XLR 3 pole female, IDC contacts, Thermoplastic shell, IDC Jaws cable clamp	Standard	AC3FCPI
			Gold Plated Contacts	AC3FCPI-AU
			Bulk Pack	AC3FCPI-BULK

**Note:** Amphenol can not guarantee the termination performance unless the recommended cable dimensions listed on page 21 are followed.

## PART NUMBER BREAKDOWN

### IDC THERMOPLASTIC SHELL TYPE

E. G. **AC3MCPI-AU BULK**  
**AC** (Series Prefix), **3** contacts, **Male**, **CP** (Thermoplastic Shell), IDC Contacts, **-AU** (Gold Plated Contacts), **Bulk** Packaged.

<b>SERIES PREFIX</b>	AC	=	Series Prefix
<b>CONTACT LAYOUT</b>	3	=	3 Contacts only
<b>GENDER</b>	F	=	Female Socket Contacts
	M	=	Male Pin Contacts
<b>SHELL MATERIAL</b>	CP	=	Thermoplastic Shell
<b>TERMINATION METHOD</b>	I	=	IDC Contacts
<b>CONTACT PLATING</b>	Blank	=	Standard Plating ( Silver or Tin - Refer to Standard Data.)
	AU	=	Gold Plated
<b>PACKAGING</b>	Blank	=	Individual Bags
	BULK	=	Bulk Packed

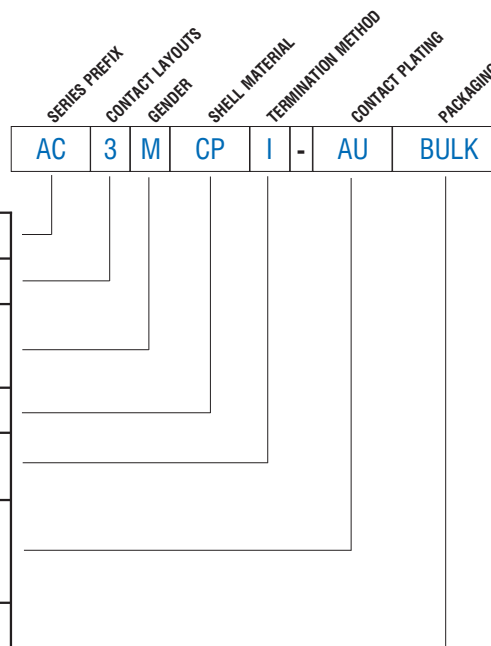

**Note:** All AC Series Connectors are available with optional colour coded boot / backshell. Refer to page 80 and simply add colour to end of part number. Example: AC3MCPI - RED

# Amphenol

## AC IDC SERIES CABLE ASSEMBLY INSTRUCTIONS

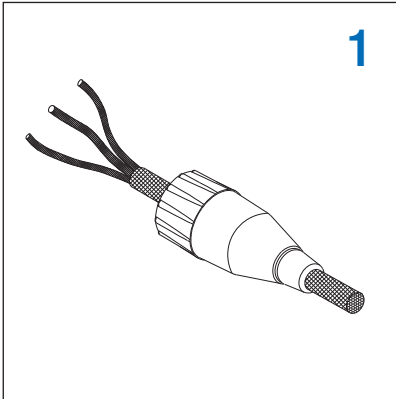
**1**

Push the cable through the boot assembly and strip the cable back 35 to 40 mm. Twist the shield wire.

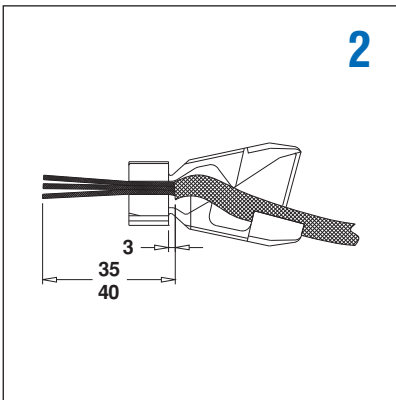
**2**

Fit the cable into the 'Jaws' cable clamp ensuring that the cable is pushed up to the neck of the clamp within 3mm.

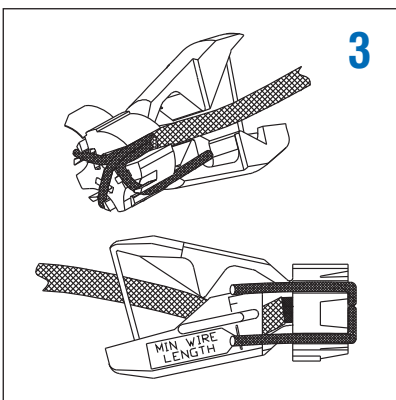
**3**

Pull back the conductors into their individual wire guidetracks. Note: Two spring fingers in the clamp will hold the conductors in position during subsequent operations. The ends of the two insulated wires must be on or past the minimum wire length mark.

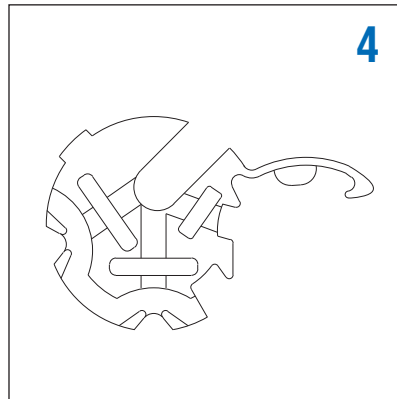
**4**

For ground protection the twisted shield wire is clipped in place with the ground protect flap.

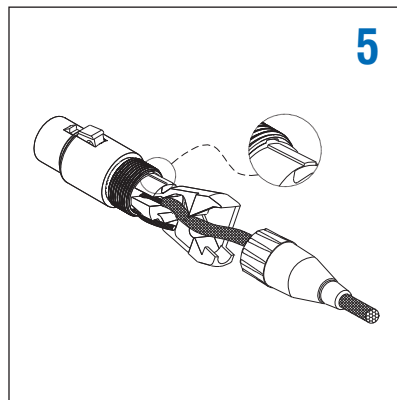
**5**

Trim back the shield wire, so there are no wires coming out of the flap and fit the 'Jaws' cable clamp into the shell assembly, ensuring the keyways are aligned.

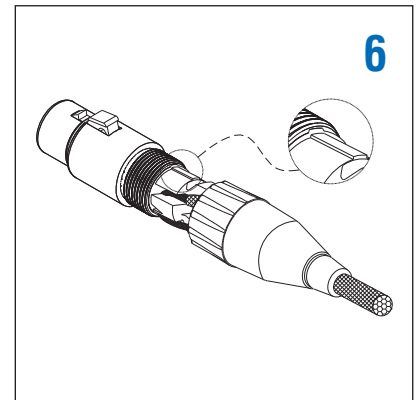
**6**

Close the cable clamp slightly and push the boot over the clamp ensuring the wires fit inside the boot.

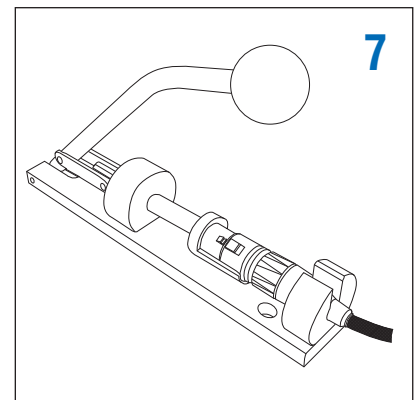

**7**

Final assembly can be achieved either by manually screwing the boot on, or by using an Amphenol Australia T2860 termination tool.

# Amphenol

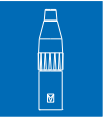
## STANDARD DATA AC CABLE CONNECTORS

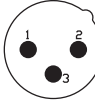
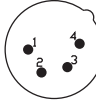
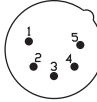
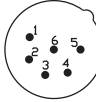
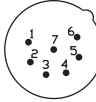

		VALUE				
<b>GENERAL CHARACTERISTICS</b>	Number of contacts	3	4	5	6A	7
	AC Series Contact Arrangements (Front view of pin inserts)					
	Termination	IDC / SOLDER	SOLDER	SOLDER	SOLDER	SOLDER
	Max. Wire Gauge - Stranded wire:					
	IDC	24AWG	N/A	N/A	N/A	N/A
	Solder	14AWG	16AWG	18AWG	18AWG	20AWG
	Flammability rating of insulator plastics and housings	UL94V-0				
Environmental	Complies with RoHS Directive 2002/95/EC					
<b>ELECTRICAL CHARACTERISTICS</b>	Service Voltage RMS	133V <sup>1)</sup>				
	Test Voltage AC RMS	1400V				
	Current carrying capacity:					
	IDC	1A	N/A	N/A	N/A	N/A
	Solder	15A	10A	7.5A	7.5A	5A
	Typical Contact Resistance	≤3mΩ				
Insulation Resistance	≥1GΩ					
<b>CLIMATIC CHARACTERISTICS</b>	Protection Class	IP40				
	Operating Temperature	-25°C to +75°C (-13°F to +167°F)				
<b>MECHANICAL CHARACTERISTICS</b>	Insertion and Withdrawal force	≥10N - ≤30N				
	Weight - Metal <sup>2)</sup>	36g (0.080lb)	37g (0.081lb)	38g (0.083lb)	38g (0.083lb)	38g (0.083lb)
	Weight - Thermoplastic <sup>2)</sup>	18g (0.039lb)	19g (0.041lb)	20g (0.044lb)	20g (0.044lb)	20g (0.044lb)
	Typical Cable retention force	22Kg to 44Kg (50lb to 100lb) - Dependent on cable material and diameter.				
	Cable O.D. range - JAWS clamp					
	IDC	Max. Cable O.D. 5.85mm (0.23")				
	Standard solder	3mm to 6.5mm (0.118" to 0.255")				
	Large Solder	6.5mm to 8mm (0.255" to 0.314")				
Mechanical Operations	1000 mating cycles					

<sup>1)</sup> Not suitable for domestic applications above 50V

<sup>2)</sup> Approximate weight only, does not include packaging. Please contact us for exact weight for shipping purposes.

# Amphenol

## STANDARD DATA AC CABLE CONNECTORS

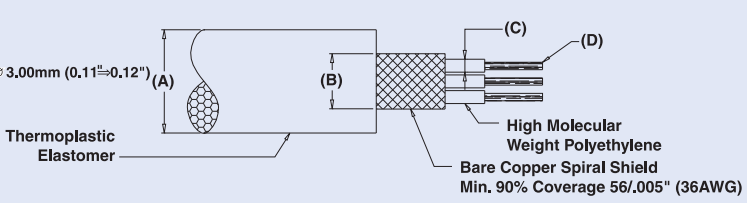
		DETAILS
<b>MATERIALS</b>	Connector shell - Metal	Diecast Zinc Alloy
	Shell finish	Satin nickel or Black polyester
	Connector shell - Thermoplastic	Thermoplastic, UL94V-0 Modified PPE Resin
	Shell finish	Black
	Insulators	UL94V-0 PBT Resin or Modified PPE Resin
	Boot / Backshell	UL94V-0 Modified PPE Resin or Machined Brass
	Finish	Black, other colours available - see page 80
	Cable clamp	
	IDC Socket JAWS	UL94V-0 Modified PPO Resin (Pink)
	IDC Pin JAWS	UL94V-0 Modified PPO Resin (Blue)
	Standard Solder JAWS	UL94V-0 Modified PPO Resin (Black)
	Large Solder JAWS	UL94V-0 Modified PPO Resin (Purple)
	Cable Bushing	Thermoplastic Polyurethane
	Male Contact	
	Stamped - IDC / Plating	Phosphor Bronze / Silver or Gold (Optional)
	Stamped - Solder / Plating	Phosphor Bronze / Silver or Gold (Optional)
Machined - Solder / Plating	Brass / Silver or Gold (Optional)	
Female Contact		
Stamped - IDC / Plating	Phosphor Bronze / Tin or Gold (Optional)	
Stamped - Solder / Plating	Phosphor Bronze / Tin or Gold (Optional)	
Machined - Solder / Plating	Brass / Silver or Gold (Optional)	
<b>IDC RECOMMENDED CABLE DIMENSIONS</b>	 <p>                     A - Cable O.D.: Max. <math>\varnothing</math> 5.85mm (0.23").                      B - Bare Copper Spiral Shield OD <math>\varnothing</math> 2.75 <math>\Rightarrow</math> <math>\varnothing</math> 3.00mm (0.11" <math>\Rightarrow</math> 0.12")                      C - OD <math>\varnothing</math> 1.30 <math>\Rightarrow</math> <math>\varnothing</math> 1.50mm (0.05" <math>\Rightarrow</math> 0.06")                      D - 16/.005" (24 AWG stranded wire)                 </p> <p>                     Thermoplastic Elastomer                      High Molecular Weight Polyethylene                      Bare Copper Spiral Shield                      Min. 90% Coverage 56/.005" (36AWG)                 </p>	



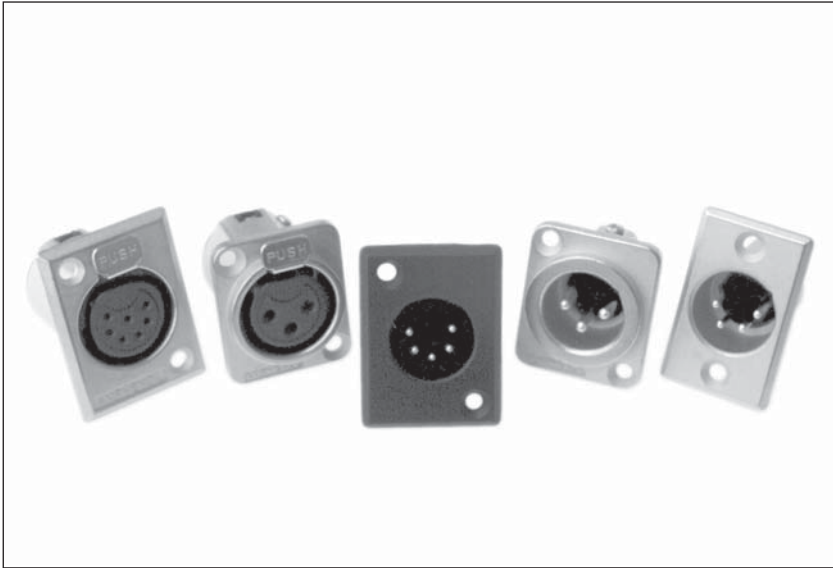

## AC “Z” SERIES XLR METAL CHASSIS MOUNT CONNECTORS

The metal chassis mount “Z” series connectors are designed for the audio user where durability, reliability and strength across a wide range of applications are important. All AC products are manufactured to the highest quality standards and will withstand the harshest environments. This range complies with IEC268-12 and AES 14-1992 standards. CSA File Number 68598

### Features

- The “D” size housing can be either front or rear mounted using the same panel cutout.
- The “P” size housing is the original wide flange front mounting XLR connector. “PN” is the original narrow flange front mounting male connector.
- A leading first mate last break socket contact is standard on all female connectors (Pin 1).
- Solder cup or Vertical PCB versions.
- Connectors are fitted with a grounding system for RFI shielding applications.
- Available in 3, 4, 5, 6A and 7 contact arrangements.
- Compatible with all other XLR brands.

### Options

- Solder Bucket termination
- Vertical PCB contacts
- Zinc Diecast Shell - Satin Nickel Finish
- Zinc Diecast Shell - Black Polyester Finish
- Gold, Silver or Tin Plated Contacts
- Bulk Packaging
- Single Bag packs
- Precision machined contacts
- Cost effective stamped contacts on 3 pole
- Latchless versions (Non-Latching) (Female only)

**Note:** A ground tag is standard on all AC “Z” series connectors. Although the ground tag is intended for RFI shielding applications, Amphenol cannot guarantee its effectiveness in all cases.

The non-conductive Black polyester finish insulates the ground tag from the shell and should not be used in applications requiring ground contact to the shell.

### Ordering Codes

We have listed the more common ordering codes in each section. For further options please refer to the part number breakdown charts. Please contact us if you need any further assistance.

### Simple steps to guide you in using this catalogue

- 1) Identify the product group listed in Contents on Page 1 and go directly to that page number.
- 2) Each product group cover page then details information and options available.
- 3) Refer to the product detail pages and identify the product you require pictorially.
- 4) Read the product description column for the products standard features.
- 5) Use variations column to determine your choice.
- 6) Identify part number.
- 7) In the event the particular option you require is not listed please refer to the part number breakdown page at the end of each section.
- 8) Please contact us directly if you have any further problems.





**Features:**

- Zinc Diecast Shell.
- D size housing can be front or rear mounted using the same panel cutout.
- Solder Bucket connections.
- Vertical PCB mounting (not available in 4 contact female).
- Precision machined or Stamped contacts (3 pin only).
- Leading first mate last break socket contact.
- Positive latch lock system.

**Options:** Stamped contacts (3 contact only), Gold plated contacts, Vertical PCB contacts, Black finish, Non-Latching (Female only), Bulk Pack.

**Part Number Breakdown: Page 31**

**Specifications: Page 32**

**PCB Footprints: Page 33**

**Panel Cutouts: Page 33**



PRODUCT - FIGURE	DRAWING	Dimensions in mm (inches)	DESCRIPTION	VARIATIONS	PART NUMBER
		<p>SOLDER CONTACTS: 2.7 [.106\"/&gt; </p>	XLR 3 pole male, D Flange, Machined contacts, Nickel Finish	Standard	AC3MMDZ
			XLR 3 pole male, D Flange, Machined contacts, Black Finish	Gold Plated Contacts	AC3MMDZ-AU
		<p>PCB CONTACTS: 27.5 [1.082\"/&gt; </p>	XLR 3 pole male, D Flange, Machined contacts, Black Finish	Vertical PCB	AC3MMDZV
			XLR 3 pole male, D Flange, Machined contacts, Black Finish	Bulk Pack	AC3MMDZ BULK
		<p>SOLDER CONTACTS: 2.7 [.106\"/&gt; </p>	XLR 3 pole male, D Flange, Stamped contacts, Nickel Finish	Standard	AC3MMDZB
			XLR 3 pole male, D Flange, Stamped contacts, Black Finish	Gold Plated Contacts	AC3MMDZB-AU
		<p>PCB CONTACTS: 27.5 [1.082\"/&gt; </p>	XLR 3 pole male, D Flange, Stamped contacts, Black Finish	Vertical PCB	AC3MMDZVB
			XLR 3 pole male, D Flange, Stamped contacts, Black Finish	Bulk Pack	AC3MMDZB BULK
		<p>SOLDER CONTACTS: 2.7 [.106\"/&gt; </p>	XLR 3 pole male, D Flange, Stamped contacts, Nickel Finish	Standard	AC3MDZ
			XLR 3 pole male, D Flange, Stamped contacts, Black Finish	Gold Plated Contacts	AC3MDZ-AU
		<p>PCB CONTACTS: 27.5 [1.082\"/&gt; </p>	XLR 3 pole male, D Flange, Stamped contacts, Black Finish	Vertical PCB	AC3MDZV
			XLR 3 pole male, D Flange, Stamped contacts, Black Finish	Bulk Pack	AC3MDZ BULK
		<p>SOLDER CONTACTS: 2.7 [.106\"/&gt; </p>	XLR 3 pole male, D Flange, Stamped contacts, Black Finish	Standard	AC3MDZB
			XLR 3 pole male, D Flange, Stamped contacts, Black Finish	Gold Plated Contacts	AC3MDZB-AU
		<p>PCB CONTACTS: 27.5 [1.082\"/&gt; </p>	XLR 3 pole male, D Flange, Stamped contacts, Black Finish	Vertical PCB	AC3MDZVB
			XLR 3 pole male, D Flange, Stamped contacts, Black Finish	Bulk Pack	AC3MDZB BULK
		<p>SOLDER CONTACTS: 6.5 [.256\"/&gt; </p>	XLR 3 pole female, D Flange, Stamped contacts, Nickel Finish	Standard	AC3FDZ
			XLR 3 pole female, D Flange, Stamped contacts, Nickel Finish	Gold Plated Contacts	AC3FDZ-AU
		<p>PCB CONTACTS: 23.0 [.907\"/&gt; </p>	XLR 3 pole female, D Flange, Stamped contacts, Nickel Finish	Vertical PCB	AC3FDZV
			XLR 3 pole female, D Flange, Stamped contacts, Black Finish	Bulk Pack	AC3FDZ BULK
		<p>SOLDER CONTACTS: 5.5 [.217\"/&gt; </p>	XLR 3 pole female, D Flange, Stamped contacts, Black Finish	Standard	AC3FDZB
			XLR 3 pole female, D Flange, Stamped contacts, Black Finish	Gold Plated Contacts	AC3FDZB-AU
		<p>PCB CONTACTS: 23.0 [.907\"/&gt; </p>	XLR 3 pole female, D Flange, Stamped contacts, Black Finish	Vertical PCB	AC3FDZVB
			XLR 3 pole female, D Flange, Stamped contacts, Black Finish	Bulk Pack	AC3FDZB BULK

PRODUCT - FIGURE	DRAWING	DESCRIPTION	VARIATIONS	PART NUMBER
		XLR 4 pole male, D Flange, Machined contacts, Nickel Finish	Standard	AC4MDZ
			Gold Plated Contacts	AC4MDZ-AU
		XLR 4 pole male, D Flange, Machined contacts, Black Finish	Vertical PCB	AC4MDZV
			Bulk Pack	AC4MDZ BULK
		XLR 4 pole female, D Flange, Machined contacts, Nickel Finish	Standard	AC4FDZ
			Gold Plated Contacts	AC4FDZ-AU
		XLR 4 pole female, D Flange, Machined contacts, Black Finish	Vertical PCB	AC4FDZV
			Bulk Pack	AC4FDZ BULK
		XLR 5 pole male, D Flange, Machined contacts, Nickel Finish	Standard	AC5MDZ
			Gold Plated Contacts	AC5MDZ-AU
		XLR 5 pole male, D Flange, Machined contacts, Black Finish	Vertical PCB	AC5MDZV
			Bulk Pack	AC5MDZ BULK
		XLR 5 pole female, D Flange, Machined contacts, Nickel Finish	Standard	AC5FDZ
			Gold Plated Contacts	AC5FDZ-AU
		XLR 5 pole female, D Flange, Machined contacts, Black Finish	Vertical PCB	AC5FDZV
			Bulk Pack	AC5FDZ BULK
		XLR 5 pole male, D Flange, Machined contacts, Nickel Finish	Standard	AC5MDZB
			Gold Plated Contacts	AC5MDZB-AU
		XLR 5 pole male, D Flange, Machined contacts, Black Finish	Vertical PCB	AC5MDZVB
			Bulk Pack	AC5MDZB BULK
		XLR 5 pole female, D Flange, Machined contacts, Nickel Finish	Standard	AC5FDZB
			Gold Plated Contacts	AC5FDZB-AU
		XLR 5 pole female, D Flange, Machined contacts, Black Finish	Vertical PCB	AC5FDZVB
			Bulk Pack	AC5FDZB BULK





PRODUCT - FIGURE	DRAWING	DESCRIPTION	VARIATIONS	PART NUMBER
		XLR 6A pole male, D Flange, Machined contacts, Nickel Finish	Standard	AC6AMDZ
			Gold Plated Contacts	AC6AMDZ-AU
		XLR 6A pole male, D Flange, Machined contacts, Black Finish	Vertical PCB	AC6AMDZV
			Bulk Pack	AC6AMDZ BULK
		XLR 6A pole male, D Flange, Machined contacts, Black Finish	Standard	AC6AMDZB
			Gold Plated Contacts	AC6AMDZB-AU
		XLR 6A pole male, D Flange, Machined contacts, Black Finish	Vertical PCB	AC6AMDZVB
			Bulk Pack	AC6AMDZB BULK
		XLR 6A pole female, D Flange, Machined contacts, Nickel Finish	Standard	AC6AFDZ
			Gold Plated Contacts	AC6AFDZ-AU
		XLR 6A pole female, D Flange, Machined contacts, Black Finish	Vertical PCB	AC6AFDZV
			Bulk Pack	AC6AFDZ BULK
		XLR 6A pole female, D Flange, Machined contacts, Black Finish	Standard	AC6AFDZB
			Gold Plated Contacts	AC6AFDZB-AU
		XLR 6A pole female, D Flange, Machined contacts, Black Finish	Vertical PCB	AC6AFDZVB
			Bulk Pack	AC6AFDZB BULK
		XLR 7 pole male, D Flange, Gold Plated Machined contacts, Nickel Finish	Standard	AC7MDZ
			Vertical PCB	AC7MDZV
		XLR 7 pole male, D Flange, Gold Plated Machined contacts, Black Finish	Bulk Pack	AC7MDZ BULK
			Standard	AC7MDZB
		XLR 7 pole male, D Flange, Gold Plated Machined contacts, Black Finish	Vertical PCB	AC7MDZVB
			Bulk Pack	AC7MDZB BULK
		XLR 7 pole female, D Flange, Gold Plated Machined contacts, Nickel Finish	Standard	AC7FDZ
			Vertical PCB	AC7FDZV
		XLR 7 pole female, D Flange, Gold Plated Machined contacts, Black Finish	Bulk Pack	AC7FDZ BULK
			Standard	AC7FDZB
		XLR 7 pole female, D Flange, Gold Plated Machined contacts, Black Finish	Vertical PCB	AC7FDZVB
			Bulk Pack	AC7FDZB BULK



**Features:**

- Zinc Diecast shell.
- The P size housing is the original wide flange front mounting XLR connector. PN is the original narrow, front mounting male connector.
- Solder Bucket connections.
- Vertical PCB mounting.
- Precision Machined or Stamped contacts (3 pin only).
- Leading first mate last break socket contact.
- Positive latch lock system.

**Options:** Stamped contacts (3 contact only), Gold plated contacts, Vertical PCB contacts, Black Finish, Non-Latching (Female only), Bulk Pack.

**Part Number Breakdown: Page 31    Specifications: Page 32**  
**PCB Footprints: Page 33    Panel Cutouts: Page 33**

PRODUCT - FIGURE	DRAWING	Dimensions in mm (inches)	DESCRIPTION	VARIATIONS	PART NUMBER
		<p>2.4 [.094"]</p> <p>27.0 [1.063"]</p> <p>36.8 [1.449"]</p> <p>22.2 [.874"]</p> <p>32.1 [1.265"]</p> <p>25.5 [1.004"]</p> <p>36.5 [1.437"]</p>	<p>XLR 3 pole male, Narrow flange, Machined contacts, Nickel Finish</p>	Standard	AC3MMPNZ
				Gold Plated Contacts	AC3MMPNZ-AU
		<p>2.4 [.094"]</p> <p>27.0 [1.063"]</p> <p>36.8 [1.449"]</p> <p>22.2 [.874"]</p> <p>32.1 [1.265"]</p> <p>25.5 [1.004"]</p> <p>36.5 [1.437"]</p>	<p>XLR 3 pole male, Narrow flange, Machined contacts, Black Finish</p>	Vertical PCB	AC3MMPNZV
				Bulk Pack	AC3MMPNZ BULK
		<p>2.4 [.094"]</p> <p>27.0 [1.063"]</p> <p>36.8 [1.449"]</p> <p>22.2 [.874"]</p> <p>32.1 [1.265"]</p> <p>25.5 [1.004"]</p> <p>36.5 [1.437"]</p>	<p>XLR 3 pole male, Narrow flange, Stamped contacts, Nickel Finish</p>	Standard	AC3MMPNZB
				Gold Plated Contacts	AC3MMPNZB-AU
		<p>2.4 [.094"]</p> <p>27.0 [1.063"]</p> <p>36.8 [1.449"]</p> <p>22.2 [.874"]</p> <p>32.1 [1.265"]</p> <p>25.5 [1.004"]</p> <p>36.5 [1.437"]</p>	<p>XLR 3 pole male, Narrow flange, Stamped contacts, Black Finish</p>	Vertical PCB	AC3MMPNZVB
				Bulk Pack	AC3MMPNZB BULK
		<p>27.2 [1.070"]</p> <p>26.4 [1.039"]</p> <p>36.7 [1.445"]</p> <p>16.7 [.656"]</p> <p>2.4 [.094"]</p> <p>31.5 [1.238"]</p> <p>25.0 [0.982"]</p> <p>36.0 [1.415"]</p>	<p>XLR 3 pole male, Wide flange, Machined contacts, Nickel Finish</p>	Standard	AC3MMP
				Gold Plated Contacts	AC3MMP-AU
		<p>27.2 [1.070"]</p> <p>26.4 [1.039"]</p> <p>36.7 [1.445"]</p> <p>16.7 [.656"]</p> <p>2.4 [.094"]</p> <p>31.5 [1.238"]</p> <p>25.0 [0.982"]</p> <p>36.0 [1.415"]</p>	<p>XLR 3 pole male, Wide flange, Machined contacts, Black Finish</p>	Vertical PCB	AC3MMPV
				Bulk Pack	AC3MMP BULK
		<p>27.2 [1.070"]</p> <p>26.4 [1.039"]</p> <p>36.7 [1.445"]</p> <p>16.7 [.656"]</p> <p>2.4 [.094"]</p> <p>31.5 [1.238"]</p> <p>25.0 [0.982"]</p> <p>36.0 [1.415"]</p>	<p>XLR 3 pole male, Wide flange, Machined contacts, Black Finish</p>	Standard	AC3MMPB
				Gold Plated Contacts	AC3MMPB-AU
		<p>27.2 [1.070"]</p> <p>26.4 [1.039"]</p> <p>36.7 [1.445"]</p> <p>16.7 [.656"]</p> <p>2.4 [.094"]</p> <p>31.5 [1.238"]</p> <p>25.0 [0.982"]</p> <p>36.0 [1.415"]</p>	<p>XLR 3 pole male, Wide flange, Machined contacts, Black Finish</p>	Vertical PCB	AC3MMPVB
				Bulk Pack	AC3MMPB BULK



PRODUCT - FIGURE	DRAWING	DESCRIPTION	VARIATIONS	PART NUMBER
		XLR 3 pole male, Wide flange, Stamped contacts, Nickel Finish	Standard	AC3MP
			Gold Plated Contacts	AC3MP-AU
		XLR 3 pole male, Wide flange, Stamped contacts, Black Finish	Vertical PCB	AC3MPV
			Bulk Pack	AC3MP BULK
			Standard	AC3MPB
			Gold Plated Contacts	AC3MPB-AU
		XLR 3 pole male, Wide flange, Stamped contacts, Black Finish	Vertical PCB	AC3MPVB
			Bulk Pack	AC3MPB BULK
			Standard	AC3MPB
		XLR 3 pole female, Wide flange, Stamped contacts, Nickel Finish	Gold Plated Contacts	AC3FPZ-AU
			Vertical PCB	AC3FPZV
			Bulk Pack	AC3FPZ BULK
		XLR 3 pole female, Wide flange, Stamped contacts, Black Finish	Standard	AC3FPZB
			Gold Plated Contacts	AC3FPZB-AU
			Vertical PCB	AC3FPZVB
			Bulk Pack	AC3FPZB BULK
		XLR 4 pole male, Narrow flange, Machined contacts, Nickel Finish	Standard	AC4MPNZ
			Gold Plated Contacts	AC4MPNZ-AU
			Vertical PCB	AC4MPNZV
			Bulk Pack	AC4MPNZ BULK
		XLR 4 pole male, Narrow flange, Machined contacts, Black Finish	Standard	AC4MPNZB
			Gold Plated Contacts	AC4MPNZB-AU
			Vertical PCB	AC4MPNZVB
			Bulk Pack	AC4MPNZB BULK
		XLR 4 pole male, Wide flange, Machined contacts, Nickel Finish	Standard	AC4MP
			Gold Plated Contacts	AC4MP-AU
			Vertical PCB	AC4MPV
			Bulk Pack	AC4MP BULK
		XLR 4 pole male, Wide flange, Machined contacts, Black Finish	Standard	AC4MPB
			Gold Plated Contacts	AC4MPB-AU
			Vertical PCB	AC4MPVB
			Bulk Pack	AC4MPB BULK







PRODUCT - FIGURE	DRAWING	DESCRIPTION	VARIATIONS	PART NUMBER
		XLR 4 pole female, Wide flange, Machined contacts, Nickel Finish	Standard	AC4FPZ
			Gold Plated Contacts	AC4FPZ- AU
		XLR 4 pole female, Wide flange, Machined contacts, Black Finish	Vertical PCB	AC4FPZV
			Bulk Pack	AC4FPZ BULK
		XLR 4 pole female, Wide flange, Machined contacts, Black Finish	Standard	AC4FPZB
			Gold Plated Contacts	AC4FPZB- AU
		XLR 4 pole female, Wide flange, Machined contacts, Black Finish	Vertical PCB	AC4FPZVB
			Bulk Pack	AC4FPZB BULK
		XLR 5 pole male, Narrow flange, Machined contacts, Nickel Finish	Standard	AC5MPNZ
			Gold Plated Contacts	AC5MPNZ- AU
		XLR 5 pole male, Narrow flange, Machined contacts, Black Finish	Vertical PCB	AC5MPNZV
			Bulk Pack	AC5MPNZ BULK
		XLR 5 pole male, Wide flange, Machined contacts, Nickel Finish	Standard	AC5MP
			Gold Plated Contacts	AC5MP- AU
		XLR 5 pole male, Wide flange, Machined contacts, Black Finish	Vertical PCB	AC5MPV
			Bulk Pack	AC5MP BULK
		XLR 5 pole male, Wide flange, Machined contacts, Black Finish	Standard	AC5MPB
			Gold Plated Contacts	AC5MPB- AU
		XLR 5 pole male, Wide flange, Machined contacts, Black Finish	Vertical PCB	AC5MPVB
			Bulk Pack	AC5MPB BULK
		XLR 5 pole female, Wide flange, Machined contacts, Nickel Finish	Standard	AC5FPZ
			Gold Plated Contacts	AC5FPZ- AU
		XLR 5 pole female, Wide flange, Machined contacts, Black Finish	Vertical PCB	AC5FPZV
			Bulk Pack	AC5FPZ BULK
		XLR 5 pole female, Wide flange, Machined contacts, Black Finish	Standard	AC5FPZB
			Gold Plated Contacts	AC5FPZB- AU
		XLR 5 pole female, Wide flange, Machined contacts, Black Finish	Vertical PCB	AC5FPZVB
			Bulk Pack	AC5FPZB BULK





PRODUCT - FIGURE	DRAWING	Dimensions in mm (inches)	DESCRIPTION	VARIATIONS	PART NUMBER
			XLR 6A pole male, Narrow flange, Machined contacts, Nickel Finish	Standard	AC6AMPNZ
				Gold Plated Contacts	AC6AMPNZ- AU
				Vertical PCB	AC6AMPNZV
				Bulk Pack	AC6AMPNZ BULK
			XLR 6A pole male, Narrow flange, Machined contacts, Black Finish	Standard	AC6AMPNZB
				Gold Plated Contacts	AC6AMPNZB- AU
				Vertical PCB	AC6AMPNZVB
				Bulk Pack	AC6AMPNZB BULK
			XLR 6A pole male, Wide flange, Machined contacts, Nickel Finish	Standard	AC6AMP
				Gold Plated Contacts	AC6AMP- AU
				Vertical PCB	AC6AMPV
				Bulk Pack	AC6AMP BULK
			XLR 6A pole male, Wide flange, Machined contacts, Black Finish	Standard	AC6AMPB
				Gold Plated Contacts	AC6AMPB- AU
				Vertical PCB	AC6AMPVB
				Bulk Pack	AC6AMPB BULK
			XLR 6A pole female, Wide flange, Machined contacts, Nickel Finish	Standard	AC6AFPZ
				Gold Plated Contacts	AC6AFPZ- AU
				Vertical PCB	AC6AFPZV
				Bulk Pack	AC6AFPZ BULK
			XLR 6A pole female, Wide flange, Machined contacts, Black Finish,	Standard	AC6AFPZB
				Gold Plated Contacts	AC6AFPZB- AU
				Vertical PCB	AC6AFPZVB
				Bulk Pack	AC6AFPZB BULK
			XLR 7 pole male, Narrow flange, Gold Plated Machined contacts, Nickel Finish	Standard	AC7MPNZ
				Vertical PCB	AC7MPNZV
				Bulk Pack	AC7MPNZ BULK
			XLR 7 pole male, Narrow flange, Gold Plated Machined contacts, Black Finish	Standard	AC7MPNZB
				Vertical PCB	AC7MPNZVB
				Bulk Pack	AC7MPNZB BULK

PRODUCT - FIGURE	DRAWING	DESCRIPTION	VARIATIONS	PART NUMBER
		XLR 7 pole male, Wide flange, Gold Plated Machined contacts, Nickel Finish	Standard	AC7MP
			Vertical PCB	AC7MPV
			Bulk Pack	AC7MP BULK
		XLR 7 pole male, Wide flange, Gold Plated Machined contacts, Black Finish	Standard	AC7MPB
			Vertical PCB	AC7MPBV
			Bulk Pack	AC7MPB BULK
		XLR 7 pole female, Wide flange, Gold Plated Machined contacts, Nickel Finish	Standard	AC7FPZ
			Vertical PCB	AC7FPZV
			Bulk Pack	AC7FPZ BULK
		XLR 7 pole female, Wide flange, Gold Plated Machined contacts, Black Finish	Standard	AC7FPZB
			Vertical PCB	AC7FPZVB
			Bulk Pack	AC7FPZB BULK



## PART NUMBER BREAKDOWN

### METAL TYPE FLANGE





E. G. **AC3MMPNZVB-AU BULK**  
**AC** (Series Prefix), **3** contacts, **M**ale, **M**achined Contacts, **PN** (Narrow Flange),  
**Z** (Metal Chassis Series), **V**ertical Printed Circuit Board, **B**lack Polyester Finish,  
**AU** (Gold Plated Contacts), **BULK** Packaged.



<b>SERIES PREFIX</b>	AC	=	Series Prefix
<b>CONTACT LAYOUTS</b>	3	=	3 Contacts
	4	=	4 Contacts
	5	=	5 Contacts
	6A	=	6 Contacts
	7	=	7 Contacts
<b>GENDER</b>	F	=	Female Socket Contacts
	M	=	Male Pin Contacts
<b>MACHINED CONTACTS</b>	Blank	=	Stamped Contacts
	M	=	Machined Contacts (Applicable 3 male pin contacts only)
NOTE: 4 - 7 contact connectors have machined contacts as standard. They are not available in stamped contacts.			
<b>SHELL STYLE</b>	D	=	Small Flange (front or rear mounting)
	P	=	Large Shell with wide flange
	PN	=	Large Shell with Narrow Flange (male only)
<b>SHELL SERIES</b>	Blank	=	Male P Shell Style only
	Z	=	Metal Chassis Series
<b>TERMINATION</b>	Blank	=	Solder Buckets
	V	=	Vertical Printed Circuit Board
<b>SHELL FINISH</b>	Blank	=	Nickel Plated Finish
	B	=	Black Polyester Finish
<b>CONTACT PLATING</b>	Blank	=	Standard Plating ( Silver or Tin - Refer to Standard Data.)
	AU	=	Gold Plated
NOTE: 7 Contact is gold plated as standard.			
<b>PACKAGING</b>	Blank	=	Individual Bags
	BULK	=	Bulk Packed

**Note:** Non-Latching Versions (Female) available - Please contact us for part number options.

## STANDARD DATA AC SERIES CHASSIS - METAL "Z"

		VALUE				
<b>GENERAL CHARACTERISTICS</b>	Number of contacts	3	4	5	6A	7
	Contact Arrangement (Front view of pin inserts)					
	Termination	Solder Bucket / Printed Circuit Board (PCB)				
	Max. Wire Gauge - Stranded wire:					
	Solder	14AWG	16AWG	18AWG	18AWG	20AWG
	Printed Circuit Board - PCB	N/A	N/A	N/A	N/A	N/A
Flammability rating of plastics	UL94V-0					
Environmental	Complies with RoHS Directive 2002/95/EC					
<b>ELECTRICAL CHARACTERISTICS</b>	Service Voltage RMS	133V <sup>1)</sup>				
	Test Voltage AC RMS	1400V				
	Current carrying capacity:					
	Solder	15A	10A	7.5A	7.5A	5A
	Printed Circuit Board (PCB)	15A	10A	7.5A	7.5A	5A
	Typical Contact Resistance	≤3mΩ				
Insulation Resistance	≥1000MΩ					
<b>CLIMATIC CHARACTERISTICS</b>	Protection Class	IP40				
	Operating Temperature	-25 °C to +75 °C (-13°F to +167°F)				
<b>MECHANICAL CHARACTERISTICS</b>	Weight - Metal <sup>2)</sup>	31g (0.068lb)	32g (0.070lb)	33g (0.072lb)	33g (0.072lb)	33g (0.072lb)
	Mechanical Operations	1000 mating cycles				
<b>MATERIALS</b>	Connector Shell	Diecast Zinc Alloy				
	Shell Finish	Satin Nickel or Black Polyester				
	Insulators	UL94V-0 PBT Resin or Modified PPE Resin				
	Male Contact					
	Stamped Solder and PCB-(Material/Plating)	Phosphor Bronze / Silver or Gold (optional)				
	Machined Solder-(Material/Plating)	Brass / Silver or Gold (optional)				
	Female Contact					
Stamped Solder and PCB-(Material/Plating)	Phosphor Bronze / Tin or Gold (optional)					
Machined Solder-(Material/Plating)	Brass / Silver or Gold (Optional)					

Rev 2 - 09/2005

<sup>1)</sup> Not suitable for domestic applications above 50V

<sup>2)</sup> Approximate weight only, does not include packaging. Please contact us for exact weight for shipping purposes.

## AC SERIES CHASSIS METAL "Z"

### PCB FOOTPRINTS STRAIGHT (V)

#### CONNECTOR SIDE OF PCB

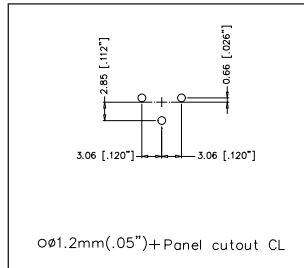

Ø01.2mm(.05") + Panel cutout CL

**AC3F\*ZV**

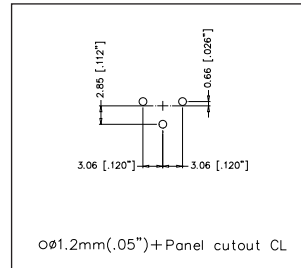

Ø01.2mm(.05") + Panel cutout CL

**AC3M\*ZV**

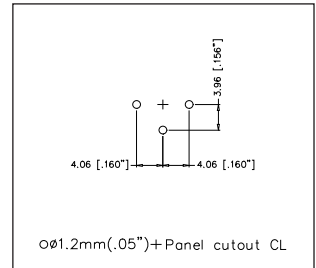

Ø01.2mm(.05") + Panel cutout CL

**AC3MM\*ZV**

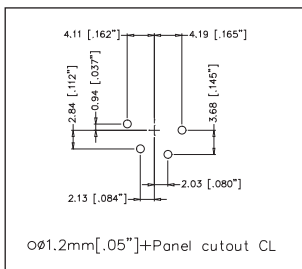

Ø01.2mm(.05") + Panel cutout CL

**AC4F\*ZV**

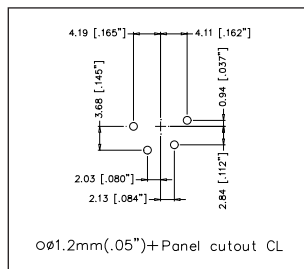

Ø01.2mm(.05") + Panel cutout CL

**AC4M\*ZV**

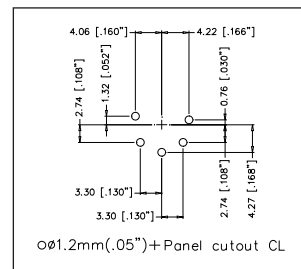

Ø01.2mm(.05") + Panel cutout CL

**AC5F\*ZV**

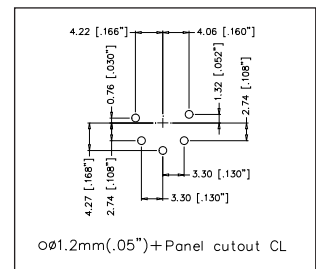

Ø01.2mm(.05") + Panel cutout CL

**AC5M\*ZV**

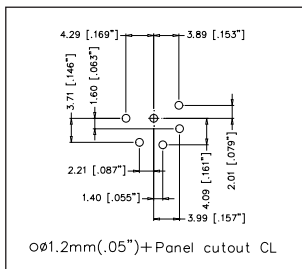

Ø01.2mm(.05") + Panel cutout CL

**AC6AF\*ZV**

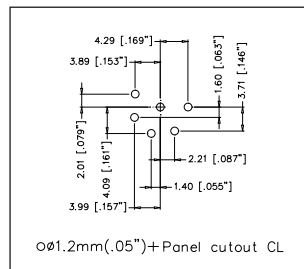

Ø01.2mm(.05") + Panel cutout CL

**AC6AM\*ZV**

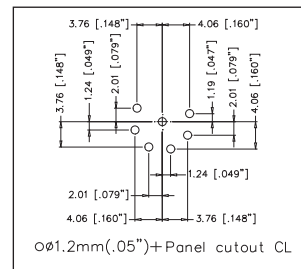

Ø01.2mm(.05") + Panel cutout CL

**AC7F\*ZV**

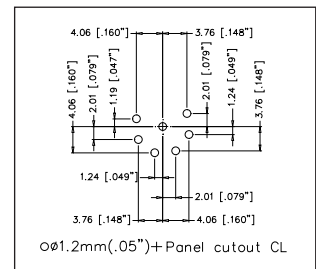

Ø01.2mm(.05") + Panel cutout CL

**AC7M\*ZV**

### PANEL CUTOUT DIMENSIONS

#### FRONT VIEW

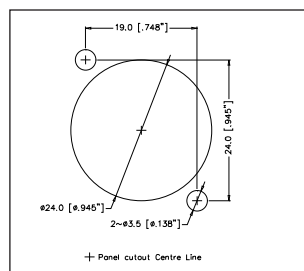

**AC\*FDZ**

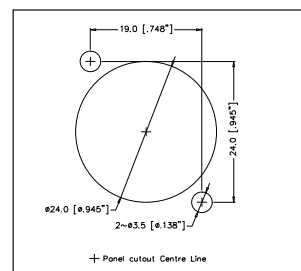

**AC\*MDZ**

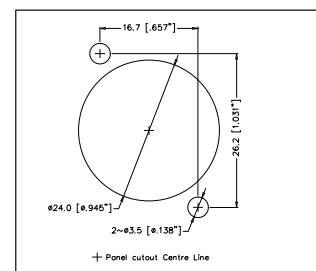

**AC\*FPZ**

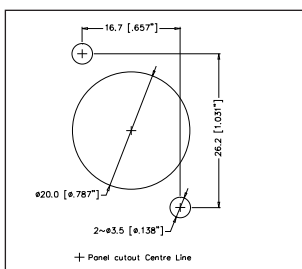

**AC\*MP**

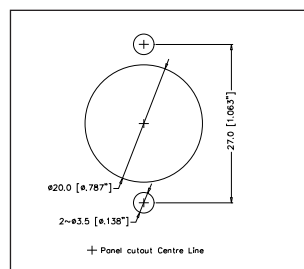

**AC\*MPNZ**

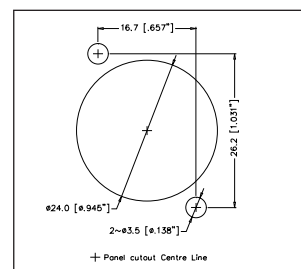

**AC-PDN-31-XXX**

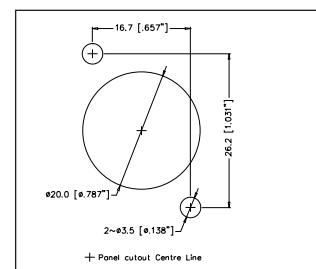

**AC-PDN-34-XXX**





## AC SERIES - A AND B TYPE XLR PCB CHASSIS CONNECTORS

The AC series, A and B type XLR chassis receptacles have been designed and manufactured with the Original Equipment Manufacturers' (OEM) needs in mind. The compact shell design allows a significant space saving over the traditional 'D' type shell. Gold plated contacts improve the performance, ensuring a reliable contact and the unique grounding link options offer flexibility in design.

### Features

- A leading first mate last break socket contact is standard on all female connectors (Pin 1).
- Vertical and Horizontal PCB versions available.
- Latching and Non-latching versions available.
- A range of different grounding options are available including:
  - Mating connector shell to Pin 1
  - Mating connector shell to Chassis
  - Mating connector shell to pin 1 to Chassis
- A type is available in 3 or 5 contacts.
- B type is available in 3 contact only.
- Compatible with all other XLR brands.
- Metal Mounting Flange (B type)

### Options

- Vertical PCB contacts
- Horizontal PCB contacts
- Precision Machined Pin contacts
- Cost effective Stamped Socket contacts
- Gold Plated contacts (Standard)
- Silver Plated contacts (Optional)
- Bulk Packaging

### Ordering Codes

We have listed the more common ordering codes in each section. For further options please refer to the part number breakdown charts. Please contact us if you need any further assistance.

### Simple steps to guide you in using this catalogue

- 1) Identify the product group listed in Contents on Page 1 and go directly to that page number.
- 2) Each product group cover page then details information and options available.
- 3) Refer to the product detail pages and identify the product you require pictorially.
- 4) Read the product description column for the products standard features.
- 5) Use variations column to determine your choice.
- 6) Identify part number.
- 7) In the event the particular option you require is not listed please refer to the part number breakdown page at the end of each section.
- 8) Please contact us directly if you have any further problems.



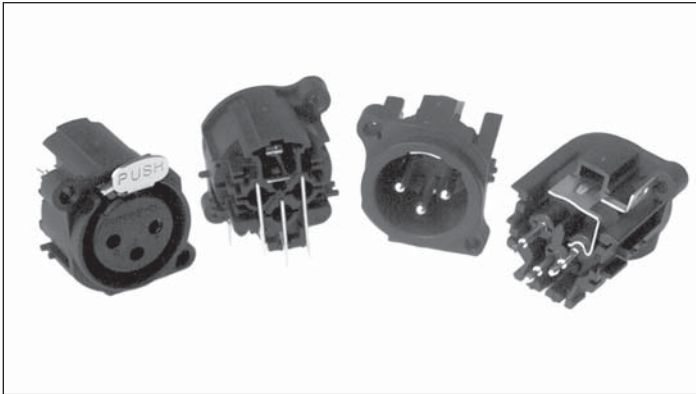

**Features:**

- Thermoplastic Shell
- Industry standard PCB footprints.
- Vertical or Horizontal PCB mounting.
- Precision machined pin contacts.
- Gold plated contacts.
- Leading first mate last break socket contact.
- Bulk packed in trays, 100 to a box as standard.
- Positive latch lock system.









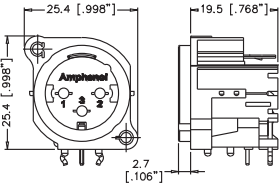

**Options:** Silver plated contacts, Vertical or Horizontal PCB, Various grounding methods, Latching or Non-Latching.

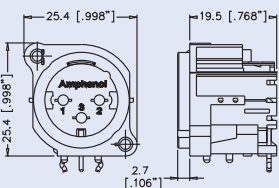
**Part Number Breakdown: Page 44-45 Specifications: Page 47**

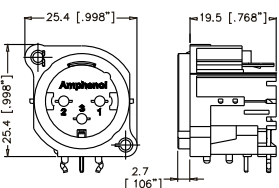
**PCB Footprints: Page 48**

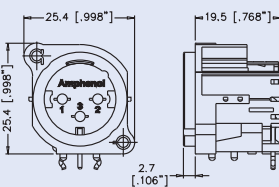
**Panel Cutouts: Page 49**

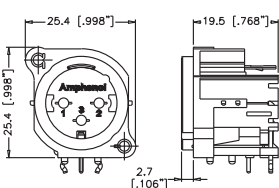

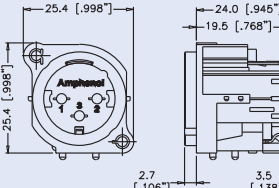





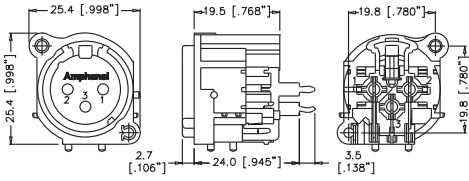

PRODUCT - FIGURE	DRAWING	Dimensions in mm (inches)	DESCRIPTION	GROUND LINK VARIATIONS	PART NUMBER
		25.4 [ .998" ] 19.5 [ .768" ] 19.8 [ .780" ] 12.5 [ .492" ] 19.8 [ .780" ] 2.7 [ .106" ]	XLR 3 pole male, Horizontal PCB, Gold Plated Contacts, Bulk Pack	No Ground Link	AC3MAH-AU-B
		25.4 [ .998" ] 19.5 [ .768" ] 19.8 [ .780" ] 12.5 [ .492" ] 19.8 [ .780" ] 2.7 [ .106" ]	XLR 3 pole male, Horizontal PCB, Gold Plated Contacts, Bulk Pack	Pin 1 to Chassis to Mating connector shell	AC3MAH1-AU-B
		25.4 [ .998" ] 19.5 [ .768" ] 19.8 [ .780" ] 12.5 [ .492" ] 19.8 [ .780" ] 2.7 [ .106" ]	XLR 3 pole male, Horizontal PCB, Gold Plated Contacts, Bulk Pack	Mating connector shell to Chassis - Pin 1 sep. Ground	AC3MAH2-AU-B
		25.4 [ .998" ] 19.5 [ .768" ] 19.8 [ .780" ] 12.5 [ .492" ] 19.8 [ .780" ] 2.7 [ .106" ]	XLR 3 pole male, Horizontal PCB, Gold Plated Contacts, Bulk Pack	Mating connector shell to Pin 1	AC3MAH3-AU-B
		25.4 [ .998" ] 19.5 [ .768" ] 19.8 [ .780" ] 12.5 [ .492" ] 19.8 [ .780" ] 2.7 [ .106" ]	XLR 3 pole male, Horizontal PCB, Gold Plated Contacts, Bulk Pack	Mating connector shell to Chassis to PCB, Pin 1 sep. Ground	AC3MAH4-AU-B
		25.4 [ .998" ] 19.5 [ .768" ] 19.8 [ .780" ] 12.5 [ .492" ] 19.8 [ .780" ] 2.7 [ .106" ] 3.5 [ .138" ]	XLR 3 pole male, Vertical PCB, Gold Plated Contacts, Bulk Pack	No Ground Link	AC3MAV-AU-B

PRODUCT - FIGURE	DRAWING	Dimensions in mm (inches)	DESCRIPTION	GROUND LINK VARIATIONS	PART NUMBER
			XLR 3 pole male, Vertical PCB, Gold Plated Contacts, Bulk Pack	Pin 1 to Chassis to Mating connector shell	AC3MAV1-AU-B
			XLR 3 pole male, Vertical PCB, Gold Plated Contacts, Bulk Pack	Mating connector shell to Chassis - Pin 1 sep. Ground	AC3MAV2-AU-B
			XLR 3 pole male, Vertical PCB, Gold Plated Contacts, Bulk Pack	Mating connector shell to Pin 1	AC3MAV3-AU-B
			XLR 3 pole male, Vertical PCB, Gold Plated Contacts, Bulk Pack	Mating connector shell to Chassis to PCB, Pin 1 sep. ground	AC3MAV4-AU-B
			XLR 3 pole female, Horizontal PCB, Latching Type, Gold Plated Contacts, Bulk Pack	No Ground Link	AC3FAH-AU-B
			XLR 3 pole female, Horizontal PCB, Latching Type, Gold Plated Contacts, Bulk Pack	Pin 1 to Chassis to Mating connector shell	AC3FAH1-AU-B
			XLR 3 pole female, Horizontal PCB, Latching Type, Gold Plated Contacts, Bulk Pack	Mating connector shell to Chassis - Pin 1 sep. Ground	AC3FAH2-AU-B
			XLR 3 pole female, Horizontal PCB, Latching Type, Gold Plated Contacts, Bulk Pack	Pin 1 to Chassis	AC3FAH3-AU-B

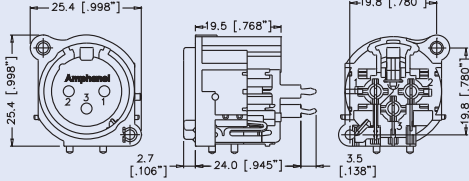

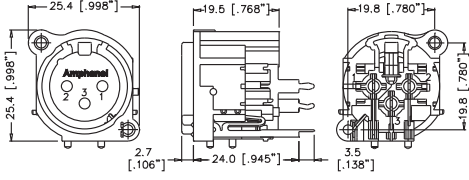

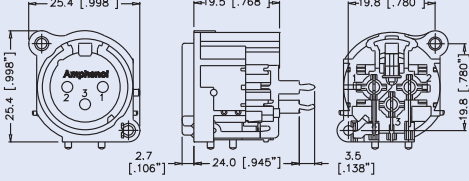
PRODUCT - FIGURE	DRAWING	Dimensions in mm (inches)	DESCRIPTION	GROUND LINK VARIATIONS	PART NUMBER
			XLR 3 pole female, Horizontal PCB, Non-Latching Type Gold Plated Contacts, Bulk Pack	No Ground Link	AC3FAHL-AU-B
			XLR 3 pole female, Horizontal PCB, Non-Latching Type Gold Plated Contacts, Bulk Pack	Pin 1 to Chassis to mating connector shell	AC3FAHL1-AU-B
			XLR 3 pole female, Horizontal PCB, Non-Latching Type Gold Plated Contacts, Bulk Pack	Mating connector shell to Chassis - Pin 1 sep. Ground.	AC3FAHL2-AU-B
			XLR 3 pole female, Horizontal PCB, Non-Latching Type Gold Plated Contacts, Bulk Pack	Pin 1 to Chassis	AC3FAHL3-AU-B
			XLR 3 pole female, Vertical PCB, Latching Type, Gold Plated Contacts, Bulk Pack	No Ground Link	AC3FAV-AU-B
			XLR 3 pole female, Vertical PCB, Latching Type, Gold Plated Contacts, Bulk Pack	Pin 1 to Chassis to mating connector shell	AC3FAV1-AU-B
			XLR 3 pole female, Vertical PCB, Latching Type, Gold Plated Contacts, Bulk Pack	Mating connector shell to Chassis - Pin 1 sep. Ground.	AC3FAV2-AU-B
			XLR 3 pole female, Vertical PCB, Latching Type, Gold Plated Contacts, Bulk Pack	Pin 1 to Chassis	AC3FAV3-AU-B

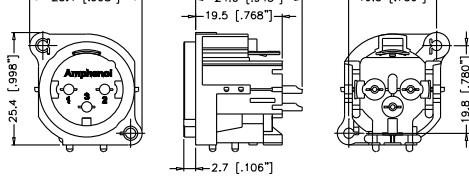
PRODUCT - FIGURE	DRAWING Dimensions in mm (inches)	DESCRIPTION	GROUND LINK VARIATIONS	PART NUMBER
		XLR 3 pole female, Vertical PCB, Non-Latching Type, Gold Plated Contacts, Bulk Pack	No Ground Link	AC3FAVL-AU-B
		XLR 3 pole female, Vertical PCB, Non-Latching Type, Gold Plated Contacts, Bulk Pack	Pin 1 to Chassis to Mating connector shell	AC3FAVL1-AU-B
		XLR 3 pole female, Vertical PCB, Non-Latching Type, Gold Plated Contacts, Bulk Pack	Mating connector shell to Chassis - Pin 1 sep. Ground.	AC3FAVL2-AU-B
		XLR 3 pole female, Vertical PCB, Non-Latching Type, Gold Plated Contacts, Bulk Pack	Pin 1 to Chassis	AC3FAVL3-AU-B
		XLR 3 pole male, Solder Buckets, Gold Plated Contacts, Bulk Pack	No Ground Link	AC3MA-AU-B







**Features:**

- Thermoplastic Shell with Metal Mounting Flange.
- Industry standard PCB footprints.
- Improved grounding performance.
- Vertical or Horizontal PCB mounting.
- Precision machined pin contacts.
- Gold plated contacts.
- Leading first mate last break socket contact.
- Bulk packed in trays, 100 to a box as standard.
- Positive latch lock system.

**Options:** Silver plated contacts, Vertical or Horizontal PCB, Various grounding methods, Latching or Non-Latching.

**Part Number Breakdown: Page 44-45 Specifications: Page 47 PCB Footprints: Page 48 Panel Cutouts: Page 49**



PRODUCT - FIGURE	DRAWING	Dimensions in mm (inches)	DESCRIPTION/ GROUND LINK	MOUNTING FLANGE VARIATIONS	PART NUMBER
		25.3 [.996"] 25.3 [.996"] 19.5 [.768"] 2.7 [.106"] 3.5 [.139"] 19.8 [.780"] 12.5 [.492"] 19.8 [.780"]	XLR 3 pole male, Horizontal PCB, Gold Plated Contacts, Bulk Pack	Nickel Finish	AC3MBH-AU-B
			No Ground Link	Black Finish	AC3MBHB-AU-B
		25.3 [.996"] 25.3 [.996"] 19.5 [.768"] 2.7 [.106"] 3.5 [.139"] 19.8 [.780"] 12.7 [.500"] 19.8 [.780"]	XLR 3 pole male, Horizontal PCB, Gold Plated Contacts, Bulk Pack	Nickel Finish	AC3MBH1-AU-B
			Pin 1 to Chassis to Mating connector shell	Black Finish	AC3MBHB1-AU-B
		25.3 [.996"] 25.3 [.996"] 19.5 [.768"] 2.7 [.106"] 3.5 [.136"] 19.8 [.780"] 12.5 [.492"] 19.8 [.780"]	XLR 3 pole male, Horizontal PCB, Gold Plated Contacts, Bulk Pack	Nickel Finish	AC3MBH2-AU-B
			Mating connector shell to Chassis - Pin 1 sep. Ground	Black Finish	AC3MBHB2-AU-B
		25.3 [.996"] 25.3 [.996"] 19.5 [.768"] 2.7 [.106"] 3.5 [.139"] 19.8 [.780"] 12.5 [.492"] 19.8 [.780"]	XLR 3 pole male, Horizontal PCB, Gold Plated Contacts, Bulk Pack	Nickel Finish	AC3MBH3-AU-B
			Mating connector shell to Pin 1	Black Finish	AC3MBHB3-AU-B
		25.3 [.996"] 25.3 [.996"] 19.5 [.768"] 2.7 [.106"] 3.5 [.139"] 19.8 [.780"] 12.5 [.492"] 19.8 [.780"]	XLR 3 pole male, Horizontal PCB, Non-Latching Type, Gold Plated Contacts, Bulk Pack	Nickel Finish	AC3MBHL-AU-B
			No Ground Link	Black Finish	AC3MBHBL-AU-B
		25.3 [.996"] 25.3 [.996"] 19.5 [.768"] 2.7 [.106"] 3.5 [.138"] 24.0 [.945"] 19.8 [.780"] 12.5 [.492"] 19.8 [.780"]	XLR 3 pole male, Vertical PCB, Gold Plated Contacts, Bulk Pack	Nickel Finish	AC3MBV-AU-B
			No Ground Link	Black Finish	AC3MBVB-AU-B





PRODUCT - FIGURE	DRAWING	Dimensions in mm (inches)	DESCRIPTION/ GROUND LINK	MOUNTING FLANGE VARIATIONS	PART NUMBER
			XLR 3 pole male, Vertical PCB, Gold Plated Contacts, Bulk Pack  Pin 1 to Chassis to Mating connector shell	Nickel Finish  Black Finish	AC3MBV1-AU-B  AC3MBVB1-AU-B
			XLR 3 pole male, Vertical PCB, Gold Plated Contacts, Bulk Pack  Mating connector shell to Chassis - Pin 1 sep. Ground	Nickel Finish  Black Finish	AC3MBV2-AU-B  AC3MBVB2-AU-B
			XLR 3 pole male, Vertical PCB, Gold Plated Contacts, Bulk Pack  Mating connector shell to Pin 1	Nickel Finish  Black Finish	AC3MBV3-AU-B  AC3MBVB3-AU-B
			XLR 3 pole female, Horizontal PCB, Latching Type, Gold Plated Contacts, Bulk Pack  No Ground Link	Nickel Finish  Black Finish	AC3FBH-AU-B  AC3FBHB-AU-B
			XLR 3 pole female, Horizontal PCB, Latching Type, Gold Plated Contacts, Bulk Pack  Pin 1 to Chassis to Mating connector shell	Nickel Finish  Black Finish	AC3FBH1-AU-B  AC3FBHB1-AU-B
			XLR 3 pole female, Horizontal PCB, Latching Type, Gold Plated Contacts, Bulk Pack  Mating connector shell to Chassis - Pin 1 sep. Ground	Nickel Finish  Black Finish	AC3FBH2-AU-B  AC3FBHB2-AU-B
			XLR 3 pole female, Horizontal PCB, Latching Type, Gold Plated Contacts, Bulk Pack  Pin 1 to Chassis	Nickel Finish  Black Finish	AC3FBH3-AU-B  AC3FBHB3-AU-B
			XLR 3 pole female, Horizontal PCB, Non-Latching Type Gold Plated Contacts, Bulk Pack  No Ground Link	Nickel Finish  Black Finish	AC3FBHL-AU-B  AC3FBHBL-AU-B





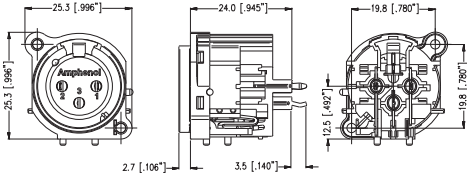

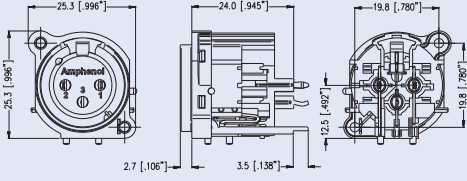
PRODUCT - FIGURE	DRAWING	Dimensions in mm (inches)	DESCRIPTION/ GROUND LINK	MOUNTING FLANGE VARIATIONS	PART NUMBER
			XLR 3 pole female, Horizontal PCB, Non-Latching Type Gold Plated Contacts, Bulk Pack  Pin 1 to Chassis to mating connector shell	Nickel Finish	AC3FBHL1-AU-B
				Black Finish	AC3FBHL1-AU-B
			XLR 3 pole female, Horizontal PCB, Non- Latching Type, Gold Plated Contacts, Bulk Pack  Mating connector shell to Chassis - Pin 1 sep. Ground.	Nickel Finish	AC3FBHL2-AU-B
				Black Finish	AC3FBHL2-AU-B
			XLR 3 pole female, Horizontal PCB, Non-Latching Type Gold Plated Contacts, Bulk Pack  Pin 1 to Chassis	Nickel Finish	AC3FBHL3-AU-B
				Black Finish	AC3FBHL3-AU-B
			XLR 3 pole female, Vertical PCB, Latching Type, Gold Plated Contacts, Bulk Pack  No Ground Link	Nickel Finish	AC3FBV-AU-B
				Black Finish	AC3FBVB-AU-B
			XLR 3 pole female, Vertical PCB, Latching Type, Gold Plated Contacts, Bulk Pack  Pin 1 to Chassis to mating connector shell	Nickel Finish	AC3FBV1-AU-B
				Black Finish	AC3FBV1-AU-B
			XLR 3 pole female, Vertical PCB, Latching Type, Gold Plated Contacts, Bulk Pack  Mating connector shell to Chassis - Pin 1 sep. Ground.	Nickel Finish	AC3FBV2-AU-B
				Black Finish	AC3FBV2-AU-B
			XLR 3 pole female, Vertical PCB, Latching Type, Gold Plated Contacts, Bulk Pack  Pin 1 to Chassis	Nickel Finish	AC3FBV3-AU-B
				Black Finish	AC3FBV3-AU-B
			XLR 3 pole female, Vertical PCB, Non-Latching Type, Gold Plated Contacts, Bulk Pack  No Ground Link	Nickel Finish	AC3FBVL-AU-B
				Black Finish	AC3FBVL-AU-B

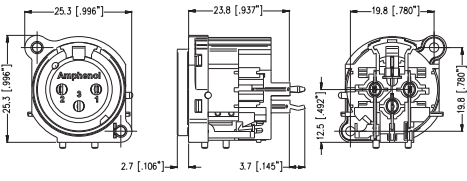
PRODUCT - FIGURE	DRAWING Dimensions in mm (inches)	DESCRIPTION/ GROUND LINK	MOUNTING FLANGE VARIATIONS	PART NUMBER
		<p>XLR 3 pole female, Vertical PCB, Non-Latching Type, Gold Plated Contacts, Bulk Pack</p> <p>Pin 1 to Chassis to Mating connector shell</p>	Nickel Finish	AC3FBVL1-AU-B
			Black Finish	AC3FBVL1-AU-B
		<p>XLR 3 pole female, Vertical PCB, Non-Latching Type, Gold Plated Contacts, Bulk Pack</p> <p>Mating connector shell to Chassis-Pin 1 sep. Ground.</p>	Nickel Finish	AC3FBVL2-AU-B
			Black Finish	AC3FBVL2-AU-B
		<p>XLR 3 pole female, Vertical PCB, Non-Latching Type, Gold Plated Contacts, Bulk Pack</p> <p>Pin 1 to Chassis</p>	Nickel Finish	AC3FBVL3-AU-B
			Black Finish	AC3FBVL3-AU-B





**Features:**

- 5 contacts.
- Thermoplastic Shell
- Industry standard PCB footprints.
- Vertical or Horizontal PCB mounting.
- Precision machined pin contacts.
- Gold plated contacts.
- Leading first mate last break socket contact.
- Bulk packed in trays, 100 to a box as standard.
- Positive latch lock system.

**Options:** Vertical or Horizontal PCB,

**Part Number Breakdown:** [Page 46](#)

**Specifications:** [Page 47](#)

**PCB Footprints:** [Page 48](#)

**Panel Cutouts:** [Page 49](#)



PRODUCT - FIGURE	DRAWING	DESCRIPTION/ GROUND LINK	MOUNTING FLANGE VARIATIONS	PART NUMBER
	<p>Dimensions in mm (inches)</p>	XLR 5 pole male, Horizontal PCB, Gold Plated Contacts, Bulk Pack	Mating connector shell to Chassis to PCB, Pin 1 sep. Ground	AC5MAH-AU-B
	<p>Dimensions in mm (inches)</p>	XLR 5 pole male, Vertical PCB, Gold Plated Contacts, Bulk Pack	Mating connector shell to Chassis to PCB, Pin 1 sep. Ground	AC5MAV-AU-B
	<p>Dimensions in mm (inches)</p>	XLR 5 pole female, Horizontal PCB, Gold Plated Contacts, Bulk Pack	Mating connector shell to Chassis to PCB, Pin 1 sep. Ground	AC5FAH-AU-B
	<p>Dimensions in mm (inches)</p>	XLR 5 pole female, Vertical PCB, Gold Plated Contacts, Bulk Pack	Mating connector shell to Chassis to PCB, Pin 1 sep. Ground	AC5FAV-AU-B

## PART NUMBER BREAKDOWN

### AC SERIES A AND B TYPE MALE - 3 CONTACT



E. G . **AC3MAVL3-AU B**  
**AC** (series prefix), **3** contacts, **M**ale, **A** Type, **V**ertical Printed Circuit Board, **L**atchless, **3** (Mating Shell to Pin 1 Grounding), - **AU** (Gold Plated Contacts), **B**ulk Packaged.

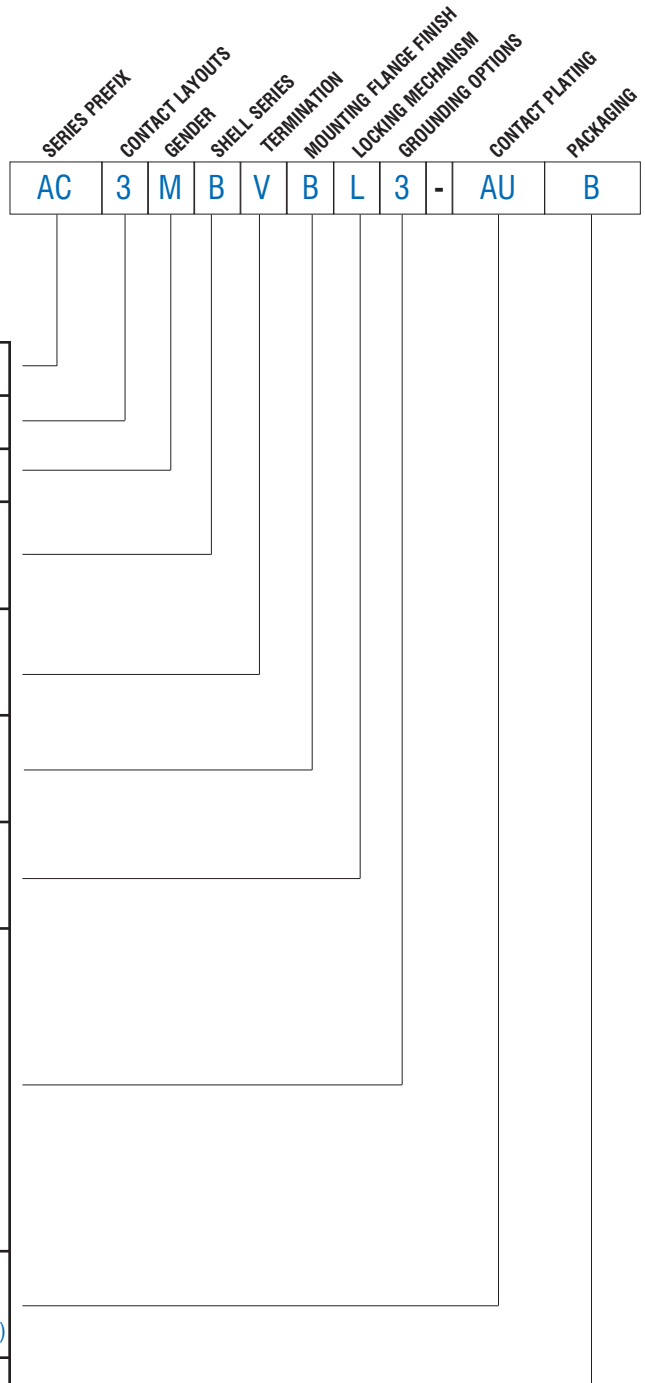

<b>SERIES PREFIX</b>	AC	=	Series Prefix
<b>CONTACT LAYOUT</b>	3	=	3 Contacts only
<b>GENDER</b>	M	=	Male Pin Contacts
<b>SHELL SERIES</b>	A	=	A Type
	B	=	B Type
<b>TERMINATION</b>	H	=	Horizontal Printed Circuit Board
	V	=	Vertical Printed Circuit Board
<b>MOUNTING FLANGE FINISH (B TYPE ONLY)</b>	Blank	=	Nickel
	B	=	Black
<b>LOCKING MECHANISM</b>	Blank	=	Latching
	L	=	Latchless
<b>GROUNDING LINK OPTIONS</b>	Blank	=	No Ground Link
	1	=	Pin 1 to Chassis to mating connector shell
	2	=	Mating connector shell to Chassis, Pin 1 separate ground.
	3	=	Mating connector to Pin 1
<b>CONTACT PLATING</b>	AU	=	Gold Plated Contacts
	AG	=	Silver Plated Contacts (Non-Standard)
<b>PACKAGING</b>	B	=	Bulk Packed

## PART NUMBER BREAKDOWN

### AC SERIES A AND B TYPE FEMALE - 3 CONTACT

E. G. **AC3FAVL3-AU B**

**AC** (series prefix), **3** contacts, **F** Female, **A** Type, **V** Vertical Printed Circuit Board, **L**atchless, **3** (Pin 1 to Chassis Grounding), - **AU** (Gold Plated Contacts), **B**ulk Packaged.

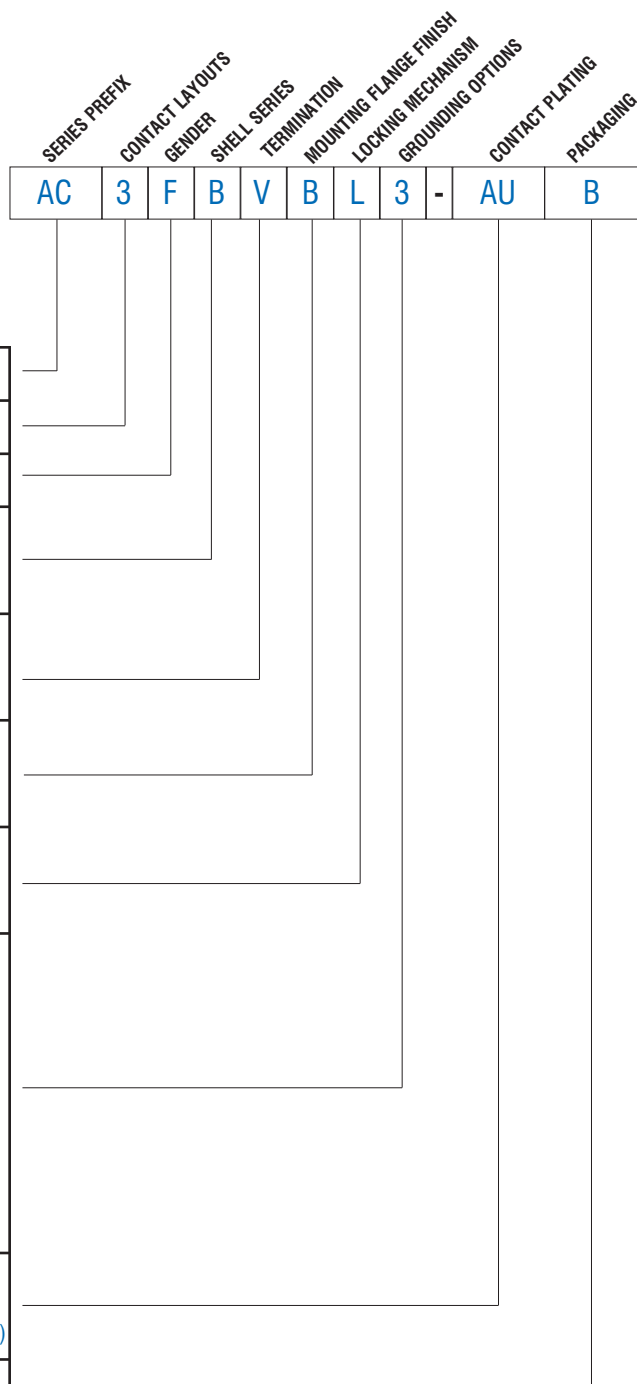

<b>SERIES PREFIX</b>	AC	=	Series Prefix
<b>CONTACT LAYOUT</b>	3	=	3 Contacts only
<b>GENDER</b>	F	=	Female Socket Contacts
<b>SHELL SERIES</b>	A	=	A Type
	B	=	B Type
<b>TERMINATION</b>	H	=	Horizontal Printed Circuit Board
	V	=	Vertical Printed Circuit Board
<b>MOUNTING FLANGE FINISH (B TYPE ONLY)</b>	Blank	=	Nickel
	B	=	Black
<b>LOCKING MECHANISM</b>	Blank	=	Latching
	L	=	Latchless
<b>GROUNDING LINK OPTIONS</b>	Blank	=	No Ground Link
	1	=	Pin 1 to Chassis to mating connector shell
	2	=	Mating connector shell to Chassis, Pin 1 separate ground.
	3	=	Pin 1 to Chassis
<b>CONTACT PLATING</b>	AU	=	Gold Plated Contacts
	AG	=	Silver Plated Contacts (Non-Standard)
<b>PACKAGING</b>	B	=	Bulk Packed

## PART NUMBER BREAKDOWN

AC SERIES A TYPE MALE AND FEMALE - 5 CONTACT



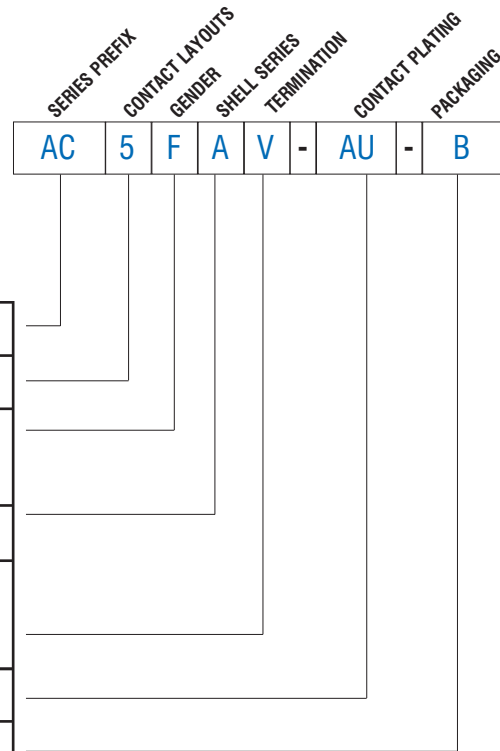

E. G . **AC5FAV-AU-B**  
**AC** (series prefix), **5** contacts, **F**emale, **A** Type, **V**ertical Printed Circuit Board,  
**AU** (Gold Plated Contacts) - **B**ulk Packaged.



<b>SERIES PREFIX</b>	AC	=	Series Prefix
<b>CONTACT LAYOUT</b>	5	=	5 Contacts only
<b>GENDER</b>	F	=	Female Socket Contacts
	M	=	Male Pin Contacts
<b>SHELL SERIES</b>	A	=	A Type
<b>TERMINATION</b>	H	=	Horizontal Printed Circuit Board
	V	=	Vertical Printed Circuit Board
<b>CONTACT PLATING</b>	AU	=	Gold Plated Contacts
<b>PACKAGING</b>	B	=	Bulk Packed



## STANDARD DATA AC SERIES A AND B TYPE CHASSIS

		VALUE	
<b>GENERAL CHARACTERISTICS</b>	Number of contacts	3	5
	Contact Arrangements (Front view of pin insert)		
	Termination	Printed Circuit Board (PCB)	
	Flammability rating of plastics	UL94V-0	UL94HB
	Environmental	Complies with RoHS Directive 2002/95/EC	
<b>ELECTRICAL CHARACTERISTICS</b>	Service Voltage RMS	133V <sup>1)</sup>	
	Test Voltage AC RMS	1500V	
	Current carrying capacity	6A	3A
	Typical Contact Resistance	≤5mΩ	
	Insulation Resistance (initial)	≥2GΩ	
	Insulation Resistance (after damp heat test)	≥1GΩ	
<b>CLIMATIC CHARACTERISTICS</b>	Protection Class	IP40	
	Operating Temperature	-25 °C to +75 °C (-13°F to +167°F)	
<b>MECHANICAL CHARACTERISTICS</b>	Weight <sup>2)</sup>	14g (0.030lb)	
	Retention Spring separating force	≥20N	
	Mounting Hole torque max.	1.5Nm	
	Mechanical Operations	1500 mating cycles	
	Fastening A Type Connectors Fastening B Type Connectors	Self-Tapping PT screw with thread 2.9 x 1.06 and of Tri-rondular configuration Self-Tapping screw M2.5	
<b>MATERIALS</b>	Connector Flange - B-Type Flange Finish - B-Type	Diecast Zinc Alloy Nickel or Black	
	Insulators	PA6.6+25% glass fibre reinforced, ULV94V-0	UL94HB
	Male Contact Material	Brass	
	Male Contact Plating	0.0762μm (3μ") gold over 0.762μm (30μ") nickel	
	Female Contact Material	Bronze	
	Female Contact Plating	0.0762μm (3μ") gold over 0.762μm (30μ") nickel	
	Latch lock and Spring	Spring Steel	
	Ground element	Spring Steel	

<sup>1)</sup> Not suitable for domestic applications above 50V

<sup>2)</sup> Approximate weight only, does not include packaging. Please contact us for exact weight for shipping purposes.



Rev 5 - 12/2008

## AC SERIES A AND B TYPE CHASSIS PCB FOOTPRINTS STRAIGHT (V) - CONNECTOR SIDE OF PCB

**AC3FAH2**  
**AC3FBH2**  
**AC3FBHB2**

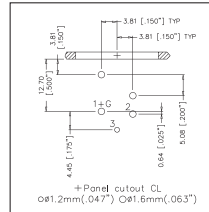
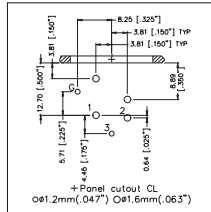

**AC3FAH1**  
**AC3FAH3**  
**AC3FBH1**  
**AC3FBHB1**  
**AC3FBH3**

**AC3FBHB3**  
**AC3FAH**  
**AC3FBH**  
**AC3FBHB**

**AC3FAV2**  
**AC3FBV2**  
**AC3FBVB2**

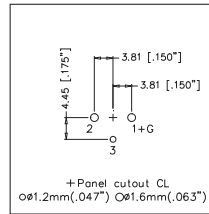
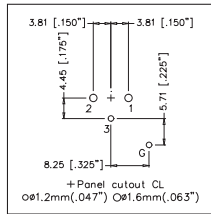

**AC3FAV1**  
**AC3FAV3**  
**AC3FBV1**  
**AC3FBVB1**  
**AC3FBV3**

**AC3FBVB3**  
**AC3FAV**  
**AC3FBV**  
**AC3FBVB**

**AC3MAH2**  
**AC3MAH4**  
**AC3MBH2**  
**AC3MBHB2**

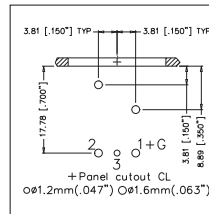
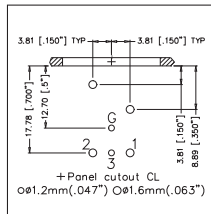

**AC3MAH1**  
**AC3MAH3**  
**AC3MBH1**  
**AC3MBHB1**  
**AC3MBH3**  
**AC3MBHB3**

**AC3MAH**  
**AC3MBH**  
**AC3MBHB**  
**AC3MBHL**  
**AC3MBHBL**

**AC3MAV2**  
**AC3MAV4**  
**AC3MBV2**  
**AC3MBVB2**

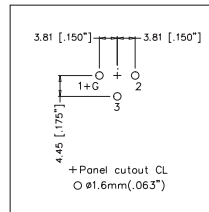
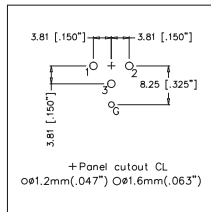

**AC3MAV1**  
**AC3MAV3**  
**AC3MBV1**  
**AC3MBVB1**  
**AC3MBV3**  
**AC3MBVB3**

**AC3MBVB3**  
**AC3MAV**  
**AC3MBV**  
**AC3MBVB**

## AC SERIES 5 PIN PCB FOOTPRINTS STRAIGHT (V) - CONNECTOR SIDE OF PCB

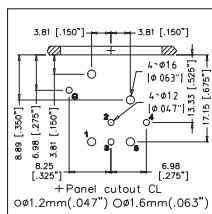

**AC5FAH**

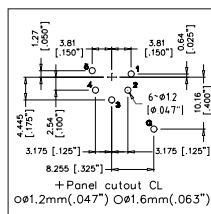

**AC5FAV**

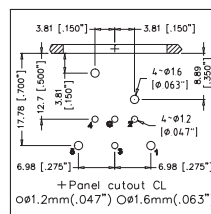

**AC5MAH**

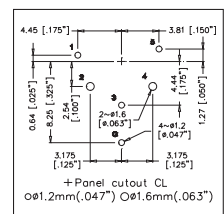

**AC5MAV**

## AC SERIES A AND B TYPE CHASSIS PANEL CUTOUT DIMENSIONS - FRONT VIEW

A TYPE

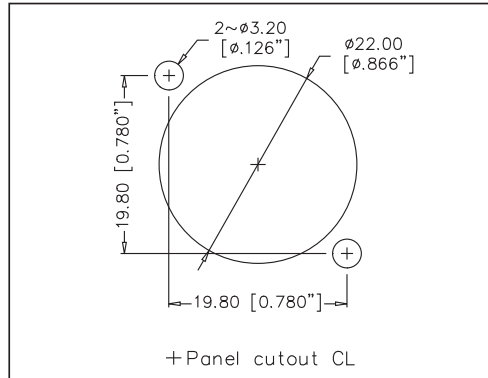

B TYPE

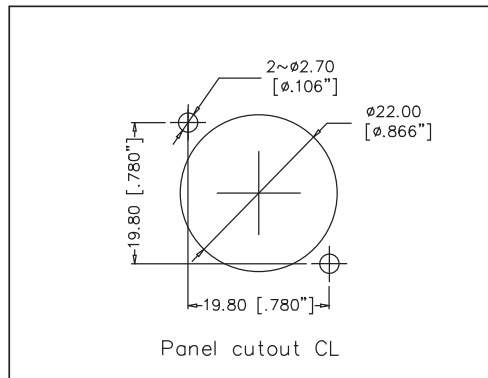

A AND B TYPE MALE  
MOUNTING PITCH

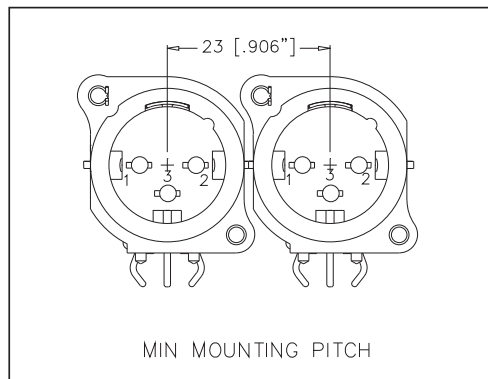

A AND B TYPE FEMALE  
MOUNTING PITCH

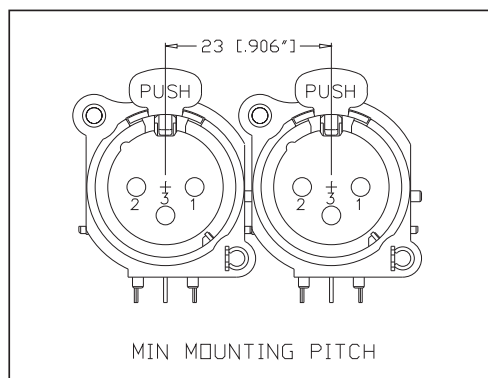

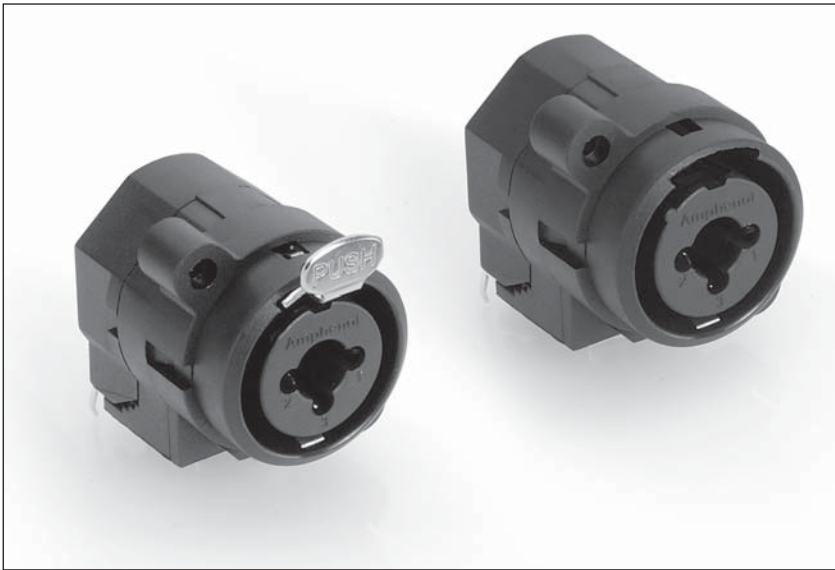

## AC SERIES-C TYPE DUAL CONNECTORS JACK/XLR

The AC Series C type chassis receptacles feature two connectors in the one space saving housing. A combined XLR female receptacle together with a 6.35mm (1/4") phone jack give the designer more flexibility ensuring premium board space is saved. Various configurations are available in either stereo or mono layouts with Vertical, Horizontal Printed Circuit Board or Solder contacts.

### Features

- Two connectors in the one housing.
- Space saving design.
- Industry standard PCB footprint layout.
- Vertical or Horizontal PCB mounting.
- Bulk packed.
- Positive latch lock system (XLR).

### Options

- Solder contacts
- Vertical PCB contacts
- Horizontal PCB contacts
- Bulk Packaging

### Ordering Codes

We have listed the more common ordering codes in each section. For further options please refer to the part number breakdown charts. Please contact us if you need any further assistance.

### Simple steps to guide you in using this catalogue

- 1) Identify the product group listed in Contents on Page 1 and go directly to that page number.
- 2) Each product group cover page then details information and options available.
- 3) Refer to the product detail pages and identify the product you require pictorially.
- 4) Read the product description column for the products standard features.
- 5) Use variations column to determine your choice.
- 6) Identify part number.
- 7) In the event the particular option you require is not listed please refer to the part number breakdown page at the end of each section.
- 8) Please contact us directly if you have any further problems.

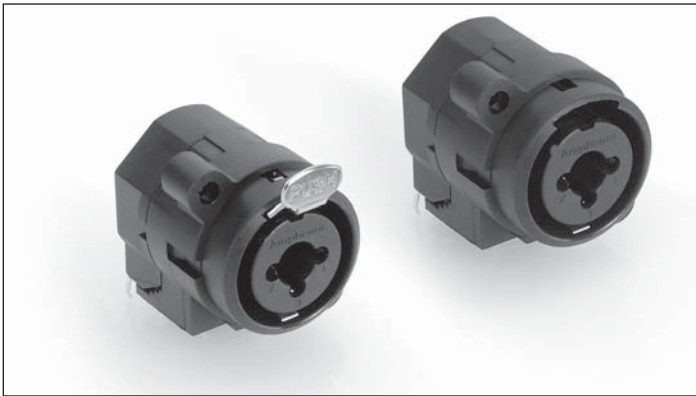

**Features:**

- Two connectors in the one housing.
- Space saving design.
- Industry standard PCB footprint layout.
- Vertical or Horizontal PCB mounting.
- Bulk packed in trays, 100 to a box as standard.
- Positive latch lock system (XLR).











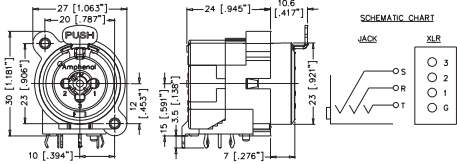

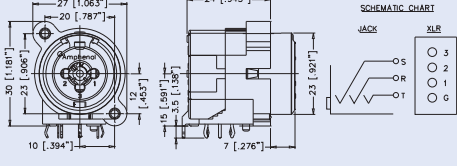

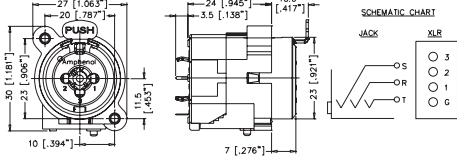
**Part Number Breakdown: Page 54**

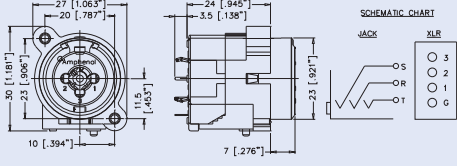
**Specifications: Page 55**

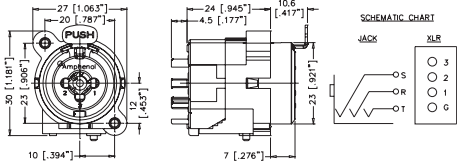
**PCB Footprints: Page 56**

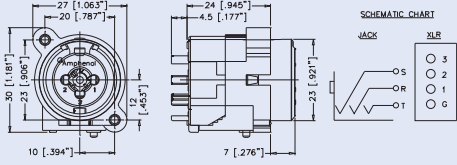
PRODUCT - FIGURE	DRAWING	Dimensions in mm (inches)	DESCRIPTION	VARIATIONS	PART NUMBER
		27 [1.063] 20 [0.787] 30 [1.181] 23 [0.906] 12 [0.472] 10 [.394] 24 [.945] 10.6 [.417] 7 [.276] 23 [.921]	XLR 3 pole female receptacle with 1/4" mono jack without switching contact, Horizontal PCB mount, Bulk Pack	Latching	ACJC5H BULK
		27 [1.063] 20 [0.787] 30 [1.181] 23 [0.906] 12 [0.472] 10 [.394] 24 [.945] 10.6 [.417] 7 [.276] 23 [.921]	XLR 3 pole female receptacle with 1/4" mono jack without switching contact, Horizontal PCB mount, Bulk Pack	Non-latching, Retention Spring	ACJC5HL BULK
		27 [1.063] 20 [0.787] 30 [1.181] 23 [0.906] 12 [0.472] 10 [.394] 24 [.945] 5.5 [0.217] 7 [.276] 23 [.921]	XLR 3 pole female receptacle with 1/4" mono jack without switching contact, Vertical PCB mount, Bulk Pack	Latching	ACJC5V BULK
		27 [1.063] 20 [0.787] 30 [1.181] 23 [0.906] 11.5 [0.453] 10 [.394] 24 [.945] 5.5 [0.217] 7 [.276] 23 [.921]	XLR 3 pole female receptacle with 1/4" mono jack without switching contact, Vertical PCB mount, Bulk Pack	Non-latching, Retention Spring	ACJC5VL BULK
		27 [1.063] 20 [0.787] 30 [1.181] 23 [0.906] 12 [0.472] 10 [.394] 24 [.945] 10.6 [.417] 4.5 [0.177] 7 [.276] 23 [.921]	XLR 3 pole female receptacle with 1/4" mono jack without switching contact, Solder Contacts, Bulk Pack	Latching	ACJC5S BULK
		27 [1.063] 20 [0.787] 30 [1.181] 23 [0.906] 12 [0.472] 10 [.394] 24 [.945] 10.6 [.417] 4.5 [0.177] 7 [.276] 23 [.921]	XLR 3 pole female receptacle with 1/4" mono jack without switching contact, Solder Contacts, Bulk Pack	Non-latching, Retention Spring	ACJC5SL BULK

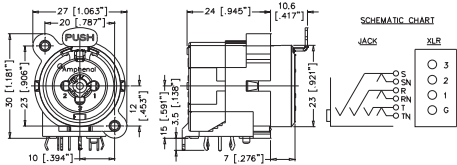

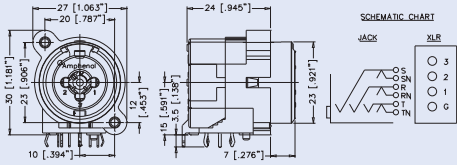

PRODUCT - FIGURE	DRAWING	Dimensions in mm (inches)	DESCRIPTION	VARIATIONS	PART NUMBER
			XLR 3 pole female receptacle with 1/4" stereo jack without switching contact, Horizontal PCB mount, Bulk Pack	Latching	ACJC6H BULK
			XLR 3 pole female receptacle with 1/4" stereo jack without switching contact, Horizontal PCB mount, Bulk Pack	Non-latching, Retention Spring	ACJC6HL BULK
			XLR 3 pole female receptacle with 1/4" stereo jack without switching contact, Vertical PCB mount, Bulk Pack	Latching	ACJC6V BULK
			XLR 3 pole female receptacle with 1/4" stereo jack without switching contact, Vertical PCB mount, Bulk Pack	Non-latching, Retention Spring	ACJC6VL BULK
			XLR 3 pole female receptacle with 1/4" stereo jack without switching contact, Solder Contacts, Bulk Pack	Latching	ACJC6S BULK
			XLR 3 pole female receptacle with 1/4" stereo jack without switching contact, Solder Contacts, Bulk Pack	Non-latching, Retention Spring	ACJC6SL BULK
			XLR 3 pole female receptacle with 1/4" switching stereo jack, Horizontal PCB mount, Bulk Pack	Latching	ACJC9H BULK
			XLR 3 pole female receptacle with 1/4" switching stereo jack, Horizontal PCB mount, Bulk Pack	Non-latching, Retention Spring	ACJC9HL BULK



PRODUCT - FIGURE	DRAWING	Dimensions in mm (inches)	DESCRIPTION	VARIATIONS	PART NUMBER
		27 [1.063] 20 [0.787] 30 [1.181] 23 [0.906] 10 [.394] 12 [.472] 24 [.945] 3.5 [.138] 10.6 [.417] 7 [.276] 23 [.921]	XLR 3 pole female receptacle with 1/4" switching stereo jack, Vertical PCB mount, Bulk Pack	Latching	ACJC9V BULK
		27 [1.063] 20 [0.787] 30 [1.181] 23 [0.906] 10 [.394] 12 [.472] 24 [.945] 3.5 [.138] 7 [.276] 23 [.921]	XLR 3 pole female receptacle with 1/4" switching stereo jack, Vertical PCB mount, Bulk Pack	Non-latching, Retention Spring	ACJC9VL BULK
		27 [1.063] 20 [0.787] 30 [1.181] 23 [0.906] 10 [.394] 12 [.472] 24 [.945] 4.5 [.177] 7 [.276] 23 [.921]	XLR 3 pole female receptacle with 1/4" switching stereo jack, Solder Contacts, Bulk Pack	Latching	ACJC9S BULK
		27 [1.063] 20 [0.787] 30 [1.181] 23 [0.906] 10 [.394] 12 [.472] 24 [.945] 4.5 [.177] 7 [.276] 23 [.921]	XLR 3 pole female receptacle with 1/4" switching stereo jack, Solder Contacts, Bulk Pack	Non-latching, Retention Spring	ACJC9SL BULK
		27 [1.063] 20 [0.787] 30 [1.181] 23 [0.906] 10 [.394] 12 [.472] 24 [.945] 3.5 [.138] 10.6 [.417] 7 [.276] 23 [.921] 15 [.591]	XLR 3 pole female receptacle with 1/4" switching stereo jack and switching ground contact, Horizontal PCB mount, Bulk Pack	Latching	ACJC10H BULK
		27 [1.063] 20 [0.787] 30 [1.181] 23 [0.906] 10 [.394] 12 [.472] 24 [.945] 3.5 [.138] 7 [.276] 23 [.921] 15 [.591]	XLR 3 pole female receptacle with 1/4" switching stereo jack and switching ground contact, Horizontal PCB mount, Bulk Pack	Non-latching, Retention Spring	ACJC10HL BULK
		27 [1.063] 20 [0.787] 30 [1.181] 23 [0.906] 10 [.394] 12 [.472] 24 [.945] 3.5 [.138] 10.6 [.417] 7 [.276] 23 [.921]	XLR 3 pole female receptacle with 1/4" switching stereo jack and switching ground contact, Vertical PCB mount, Bulk Pack	Latching	ACJC10V BULK
		27 [1.063] 20 [0.787] 30 [1.181] 23 [0.906] 10 [.394] 12 [.472] 24 [.945] 4.5 [.177] 7 [.276] 23 [.921]	XLR 3 pole female receptacle with 1/4" switching stereo jack and switching ground contact, Vertical PCB mount, Bulk Pack	Non-latching, Retention Spring	ACJC10VL BULK



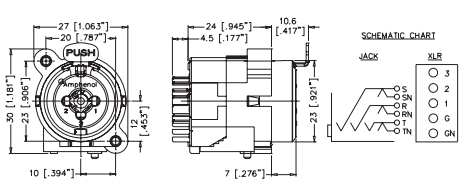

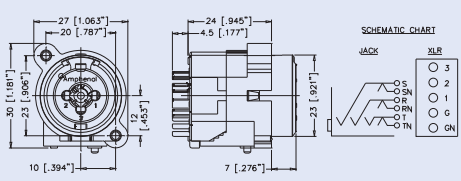
PRODUCT - FIGURE	DRAWING	DESCRIPTION	VARIATIONS	PART NUMBER
	 <p>Dimensions in mm (inches)</p> <p>SCHEMATIC CHART</p> <p>JACK</p> <p>XLR</p> <p>3 2 1 G GN</p>	XLR 3 pole female receptacle with 1/4" switching stereo jack and switching ground contact, Solder Contacts, Bulk Pack	Latching	ACJC10S BULK
	 <p>Dimensions in mm (inches)</p> <p>SCHEMATIC CHART</p> <p>JACK</p> <p>XLR</p> <p>3 2 1 G GN</p>	XLR 3 pole female receptacle with 1/4" switching stereo jack and switching ground contact, Solder Contacts, Bulk Pack	Non-latching, Retention Spring	ACJC10SL BULK

## PART NUMBER BREAKDOWN

### AC SERIES THERMOPLASTIC C TYPE

SERIES PREFIX  
CONNECTOR TYPE  
CONTACT OPTIONS  
CONTACT ORIENTATION  
LOCKING MECHANISM  
PACKAGING

AC JC 5 H L BULK

E. G. **ACJC5HL BULK**  
**AC** (Series Prefix), **JC** Jack/Connector XLR, **5** Mono, **H**orizontal Printed Circuit Board, **L**atchless, **BULK** Packaged.

<b>SERIES PREFIX</b>	AC	=	Series Prefix
<b>CONNECTOR TYPE</b>	JC	=	Jack / Connector XLR
<b>CONTACT OPTIONS</b>	5	=	Mono, Non Switching, XLR Grounded
	6	=	Stereo, Non Switching, XLR Grounded
	9	=	Stereo, Switching, XLR Grounded
	10	=	Stereo, Switching, XLR with Ground Switch
<b>CONTACT ORIENTATION</b>	V	=	Vertical Printed Circuit Board
	H	=	Horizontal Printed Circuit Board
	S	=	Solder Contacts
<b>LOCKING MECHANISM</b>	Blank	=	Latching
	L	=	Latchless
<b>PACKAGING</b>	Blank	=	Individual Bags
	BULK	=	Bulk Packed

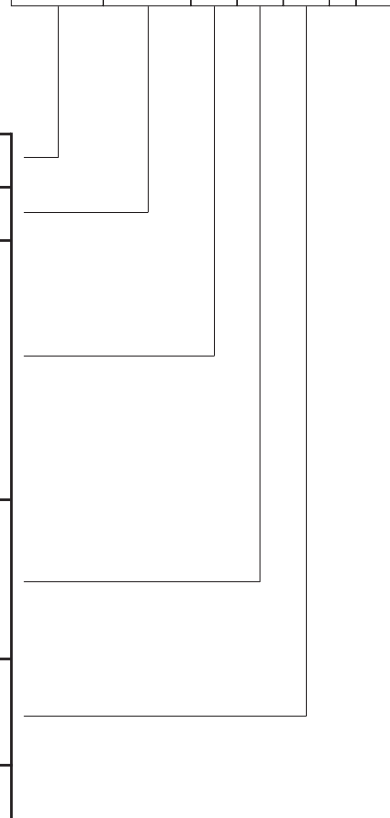

## AC SERIES C TYPE SERIES

**ACJC5H  
ACJC5HL**

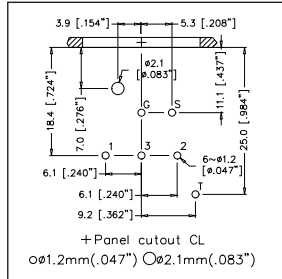

**ACJC5V  
ACJC5VL**

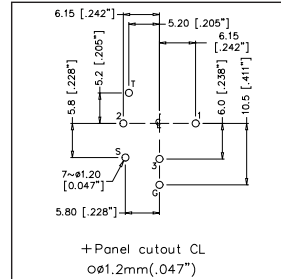

**ACJC6H  
ACJC6HL**

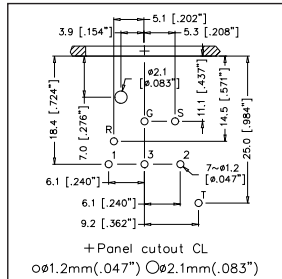

**ACJC6V  
ACJC6VL**

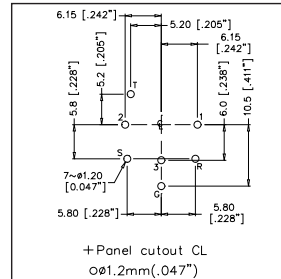

**ACJC9H  
ACJC9HL**

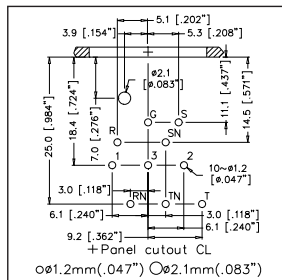

**ACJC9V  
ACJC9VL**

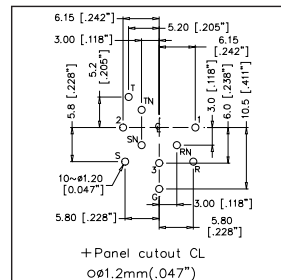

**ACJC10H  
ACJC10HL**

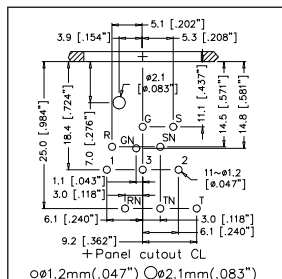

**ACJC10V  
ACJC10VL**

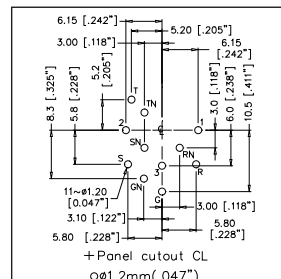

**C TYPE  
PANEL CUTOUT**

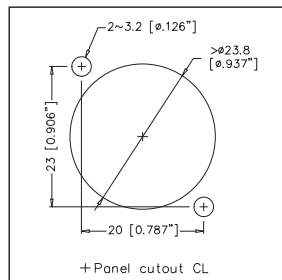

**C TYPE  
MOUNTING PITCH**

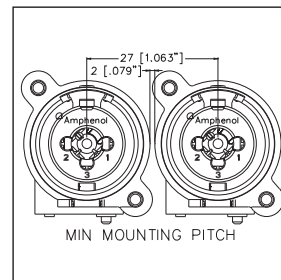

## STANDARD DATA C TYPE CHASSIS RECEPTACLES

		VALUE
<b>GENERAL CHARACTERISTICS</b>	Number of contacts	5, 6, 9 or 10
	Termination	Printed Circuit Board (PCB) or Solder Bucket
	Flammability	UL 94HB
<b>ELECTRICAL CHARACTERISTICS</b>	Service Voltage RMS	50V
	Test Voltage AC RMS	1500V
	Current carrying capacity	7.5A
	Typical Contact Resistance	≤10mΩ
	Insulation Resistance (initial)	> 2GΩ
	Insulation Resistance (after damp heat test)	> 0.5GΩ
<b>CLIMATIC CHARACTERISTICS</b>	Protection Class	IP40
	Operating Temperature	-30 °C to +80 °C
<b>MECHANICAL CHARACTERISTICS</b>	Weight**	14g (0.030lb)
	Retention Spring separating force	≥20N
	Mounting Hole torque max.	1.5Nm
	Mechanical Operations	1500 mating cycles
	Fastening	Self-Tapping PT screw with thread 2.9 x 1.06 and of Tri-rondular configuration
<b>MATERIALS</b>	Connector Shell	PA6.6 + 20% glass fibre reinforced, UL 94HB
	Shell Finish	Black
	Insulators	PA6.6 + 20% glass fibre reinforced, UL 94HB
	XLR Contact	
	Material	Bronze
	Plating	Gold over Nickel plated
	Jack Contact	
	Material	Brass
Plating	Silver over Copper plated	
Latch lock and Spring	Nickel Plated	
Ground element	Silver over Copper plated	

\*\*Approximate weight in grams not including packaging. Please contact us for exact weight for shipping purposes.

Rev 2-04/2008



## AC SERIES XLR THERMOPLASTIC CHASSIS MOUNT CONNECTORS

This receptacle is manufactured from glass filled UL94V-0 PBT Resin, and provides a lower cost alternative to the 'Z' series metal shell. Available in the small "D" or larger "P" housing or the dual versions featuring two connectors within a single housing. A positive latch lock system secures the mating cable connector. Manufactured to comply with IEC 268-12 and AES 14-1992 standards. CSA File Number 68598

### Features

- Thermoplastic Shell.
- The "D" size housing can be either front or rear mounted using the same panel cutout.
- The "P" size housing is the original front mounting XLR connector.
- Dual versions provide two connectors in the one shell.
- A leading first mate last break socket contact is standard on all female connectors (Pin 1).
- Solder cup or Insulation Displacement Contact (IDC) as well as Vertical or Horizontal PCB versions are available.
- Latching and Non-latching versions available.
- Available in 3 contact arrangements only.
- Compatible with all other XLR brands.

### Options

- Solder Bucket termination
- Insulation Displacement Contacts (IDC)
- Vertical PCB contacts
- Horizontal PCB contacts
- Gold, Silver or Tin Plated Contacts
- Bulk Packaging
- Single Bag packs
- Cost effective stamped contacts
- Latching or Non-latching.

### Ordering Codes

We have listed the more common ordering codes in each section. For further options please refer to the part number breakdown charts. Please contact us if you need any further assistance.

### Simple steps to guide you in using this catalogue

- 1) Identify the product group listed in Contents on Page 1 and go directly to that page number.
- 2) Each product group cover page then details information and options available.
- 3) Refer to the product detail pages and identify the product you require pictorially.
- 4) Read the product description column for the products standard features.
- 5) Use variations column to determine your choice.
- 6) Identify part number.
- 7) In the event the particular option you require is not listed please refer to the part number breakdown page at the end of each section.
- 8) Please contact us directly if you have any further problems.



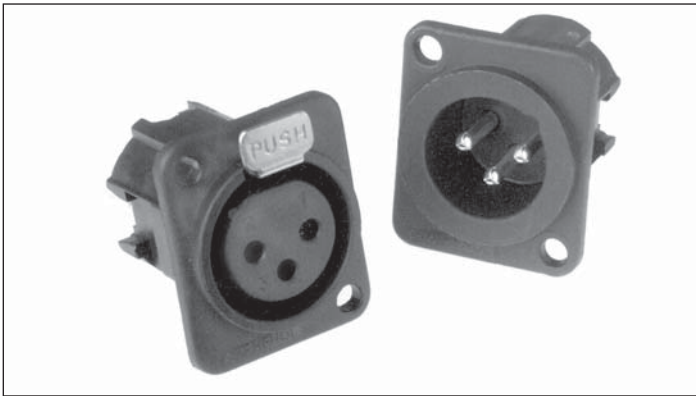

**Features:**

- Thermoplastic shell.
- D type Flange.
- Solder Bucket connections.
- Vertical or Horizontal PCB mounting.
- Stamped contacts.
- Leading first mate last break socket contact.
- Positive latch lock system.
- Coloured housings available as specials.

**Options:** Solder Buckets, Vertical or Horizontal PCB, Bulk Pack, Latching or Non-latching, Gold Plated Contacts.

**Part Number Breakdown: Page 59 Specifications: Page 68  
PCB Footprints: Page 69 Panel Cutouts: Page 69**

PRODUCT - FIGURE	DRAWING	Dimensions in mm (inches)	DESCRIPTION	VARIATIONS	PART NUMBER
			XLR 3 pole male, D Flange, Thermoplastic shell, Solder Buckets	Standard Bulk Pack Non-Latching Non-Latching Bulk	AC3MDP AC3MDP BULK AC3MDPL AC3MDPL BULK
			XLR 3 pole female, D Flange, Thermoplastic shell, Solder Buckets	Standard Bulk Pack Non-Latching Non-Latching Bulk	AC3FDP AC3FDP BULK AC3FDPL AC3FDPL BULK
			XLR 3 pole male, D Flange, Thermoplastic shell, Horizontal PCB mount	Standard Bulk Pack Non-Latching Non-Latching Bulk	AC3MDPH AC3MDPH BULK AC3MDPHL AC3MDPHL BULK
			XLR 3 pole female, D Flange, Thermoplastic shell, Horizontal PCB mount	Standard Bulk Pack Non-Latching Non-Latching Bulk	AC3FDPH AC3FDPH BULK AC3FDPHL AC3FDPHL BULK
			XLR 3 pole male, D Flange, Thermoplastic shell, Vertical PCB mount	Standard Bulk Pack Non-Latching Non-Latching Bulk	AC3MDPV AC3MDPV BULK AC3MDPVL AC3MDPVL BULK
			XLR 3 pole female, D Flange, Thermoplastic shell, Vertical PCB mount	Standard Bulk Pack Non-Latching Non-Latching Bulk	AC3FDPV AC3FDPV BULK AC3FDPVL AC3FDPVL BULK

## PART NUMBER BREAKDOWN

### THERMOPLASTIC D TYPE FLANGE

E. G. **AC3MDPVL-AU BULK**  
**AC** (Series Prefix), **3** contacts, **M**, **D** (Small Shell), **P** (Thermoplastic Chassis series)  
 Vertical Printed Circuit Board, **L**atchless - **AU** (Gold Plated Contacts), **BULK** Packaged.

<b>SERIES PREFIX</b>	AC	=	Series Prefix
<b>CONTACT LAYOUT</b>	3	=	3 Contacts only
<b>GENDER</b>	F	=	Female Socket Contacts
	M	=	Male Pin Contacts
<b>SHELL STYLE</b>	D	=	Small Shell
<b>SHELL SERIES</b>	P	=	Thermoplastic Chassis Series
<b>TERMINATION</b>	Blank	=	Solder Buckets
	V	=	Vertical Printed Circuit Board
	H	=	Horizontal Printed Circuit Board
<b>LOCKING MECHANISM</b>	Blank	=	Latching
	L	=	Latchless (Non-Latching)
<b>CONTACT PLATING</b>	Blank	=	Standard Plating (Silver or Tin - Refer to Standard Data.)
	AU	=	Gold Plated Contacts
<b>PACKAGING</b>	Blank	=	Individual Bags
	BULK	=	Bulk Packed

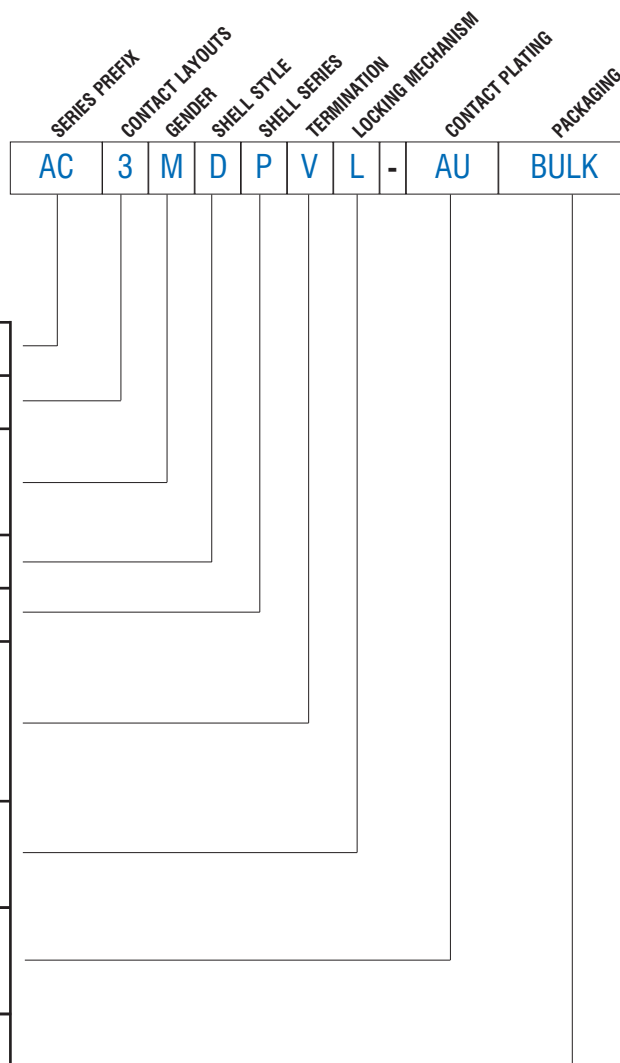





**Features:**

- Thermoplastic Shell.
- P Type Flange.
- Solder Bucket connections.
- Vertical or Horizontal PCB mounting.
- Stamped contacts.
- Leading first mate last break socket contact.
- Positive latch lock system.
- Coloured housings available as specials.

**Options:** Solder Buckets, Vertical or Horizontal PCB, Bulk Pack, Latching or Non-latching, Gold Plated Contacts.

**Part Number Breakdown: Page 61 Specifications: Page 68**  
**PCB Footprints: Page 69 Panel Cutouts: Page 69**

PRODUCT - FIGURE	DRAWING	Dimensions in mm (inches)	DESCRIPTION	VARIATIONS	PART NUMBER
			XLR 3 pole male, Wide Flange, Thermoplastic shell, Solder Buckets	Standard Bulk Pack Non-Latching Non-Latching Bulk	AC3MPP AC3MPP BULK AC3MPPL AC3MPPL BULK
			XLR 3 pole female, Wide Flange, Thermoplastic shell, Solder Buckets	Standard Bulk Pack Non-Latching Non-Latching Bulk	AC3FPP AC3FPP BULK AC3FPPL AC3FPPL BULK
			XLR 3 pole male, Wide Flange, Thermoplastic shell, Horizontal PCB mount	Standard Bulk Pack Non-Latching Non-Latching Bulk	AC3MPPH AC3MPPH BULK AC3MPPHL AC3MPPHL BULK
			XLR 3 pole female, Wide Flange, Thermoplastic shell, Horizontal PCB mount	Standard Bulk Pack Non-Latching Non-Latching Bulk	AC3FPPH AC3FPPH BULK AC3FPPHL AC3FPPHL BULK
			XLR 3 pole male, Wide Flange, Thermoplastic shell, Vertical PCB mount	Standard Bulk Pack Non-Latching Non-Latching Bulk	AC3MPPV AC3MPPV BULK AC3MPPVL AC3MPPVL BULK
			XLR 3 pole female, Wide Flange, Thermoplastic shell, Vertical PCB mount	Standard Bulk Pack Non-Latching Non-Latching Bulk	AC3FPPV AC3FPPV BULK AC3FPPVL AC3FPPVL BULK

## PART NUMBER BREAKDOWN

### THERMOPLASTIC P TYPE FLANGE

E. G. **AC3MPPVL-AU BULK**  
**AC** (Series Prefix), **3** contacts, **M** (Large Shell), **P** (Thermoplastic Chassis series)  
 Vertical Printed Circuit Board, **L**atchless - **AU** (Gold Plated Contacts), **BULK** Packaged.

<b>SERIES PREFIX</b>	AC	=	Series Prefix
<b>CONTACT LAYOUT</b>	3	=	3 Contacts Only
<b>GENDER</b>	F	=	Female Socket Contacts
	M	=	Male Pin Contacts
<b>SHELL STYLE</b>	P	=	Large Shell with wide flange
<b>SHELL SERIES</b>	P	=	Thermoplastic Chassis Series
<b>TERMINATION</b>	Blank	=	Solder Buckets
	V	=	Vertical Printed Circuit Board
	H	=	Horizontal Printed Circuit Board
<b>LOCKING MECHANISM</b>	Blank	=	Latching
	L	=	Latchless (Non-Latching)
<b>CONTACT PLATING</b>	Blank	=	Standard Plating ( Silver or Tin - Refer to Standard Data.)
	AU	=	Gold Plated Contacts
<b>PACKAGING</b>	Blank	=	Individual Bags
	BULK	=	Bulk Packed

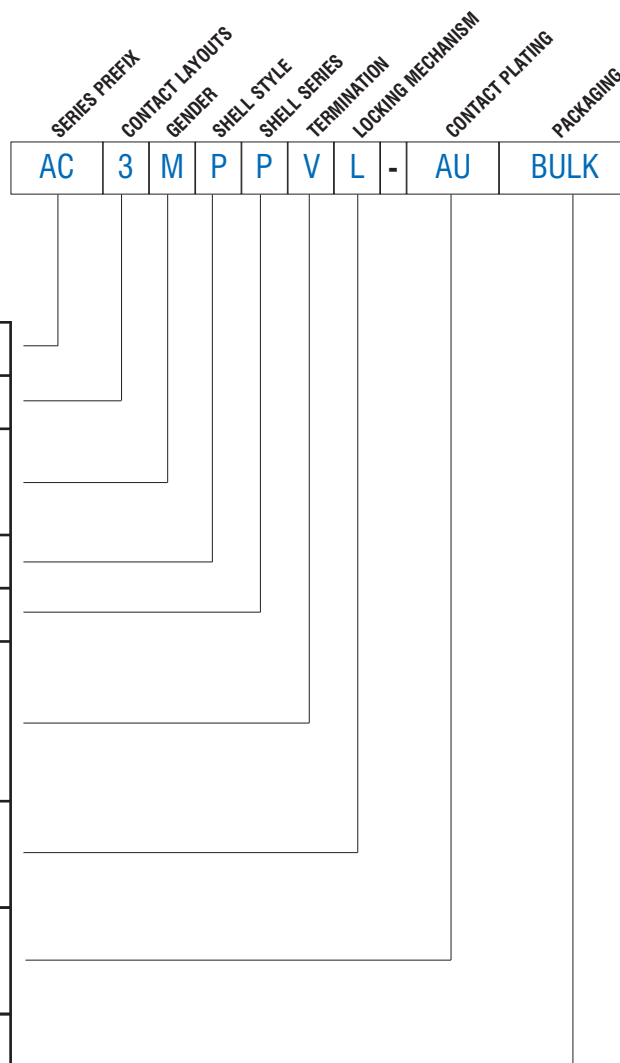

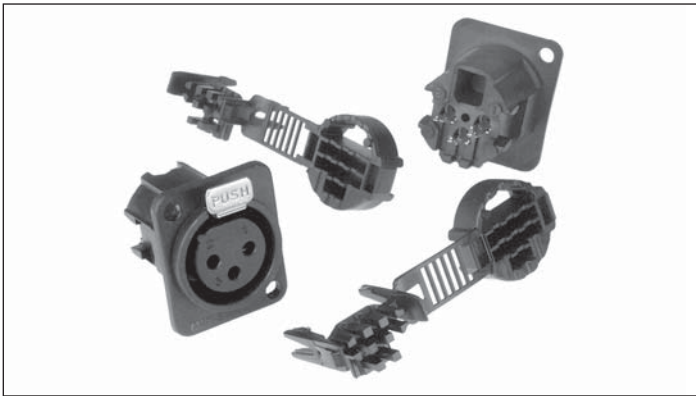

The Insulation Displacement Contact (IDC) connector is ideal for Original Equipment Manufacturers and end users alike and offers an alternative to our standard solder connector. Connectors can be quickly and easily assembled without screws or a soldering iron – by hand. Labour savings of up to 60% in termination time can be achieved.







**Recommended Cable Specifications: Page 68**

**Features:**

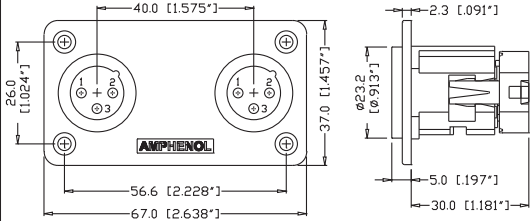
- Thermoplastic Shell.
- Optional “D”, “P” or Dual Housing flange sizes.
- Insulation Displacement Contacts (IDC)
- Stamped contacts.
- Leading first mate last break socket contact.
- Positive latch lock system.
- Coloured housings available as specials.

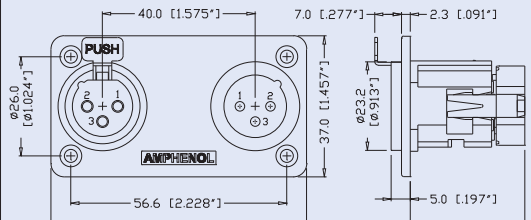
**Options:** Gold plated contacts, Bulk Pack, Latching or Non-latching  
**Part Number Breakdown: Page 64 Specifications: Page 69**  
**Assembly Instructions: Page 70 Panel Cutouts: Page 69**

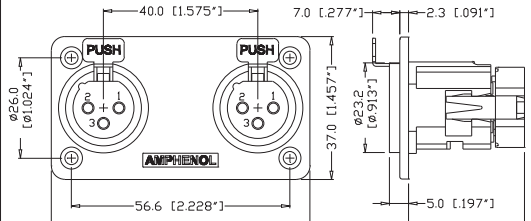
PRODUCT - FIGURE	DRAWING	Dimensions in mm (inches)	DESCRIPTION	VARIATIONS	PART NUMBER
			XLR 3 pole male, D Flange, IDC contacts, Thermoplastic shell	Standard	AC3MDPI
				Bulk Pack	AC3MDPI BULK
				Non-Latching	AC3MDPIL
				Non-Latching Bulk	AC3MDPIL BULK
			XLR 3 pole female, D Flange, IDC contacts, Thermoplastic shell	Standard	AC3FDPI
				Bulk Pack	AC3FDPI BULK
				Non-Latching	AC3FDPIL
				Non-Latching Bulk	AC3FDPIL BULK
			XLR 3 pole male, Wide Flange, IDC contacts, Thermoplastic shell	Standard	AC3MPPI
				Bulk Pack	AC3MPPI BULK
				Non-Latching	AC3MPPI L
				Non-Latching Bulk	AC3MPPI L BULK
			XLR 3 pole female, Wide Flange, IDC contacts, Thermoplastic shell	Standard	AC3FPPI
				Bulk Pack	AC3FPPI BULK
				Non-Latching	AC3FPPI L
				Non-Latching Bulk	AC3FPPI L BULK

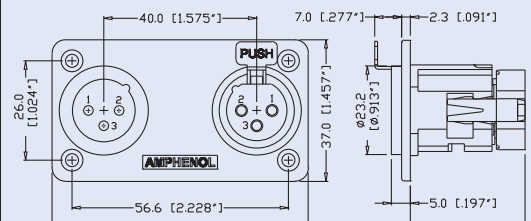
PRODUCT - FIGURE	DRAWING Dimensions in mm (inches)	DESCRIPTION	VARIATIONS	PART NUMBER
		XLR 3 pole male + 3 pole male, Dual Flange, IDC contacts, Thermoplastic shell	Latching Non-Latching	AC3M3MPPI AC3M3MPIL
		XLR 3 pole female + 3 pole male, Dual Flange, IDC contacts, Thermoplastic shell	Latching Non-Latching	AC3F3MPPI AC3F3MPIL
		XLR 3 pole female + 3 pole female, Dual Flange, IDC contacts, Thermoplastic shell	Latching Non-Latching	AC3F3FPPI AC3F3FPIL
		XLR 3 pole male + 3 pole female, Dual Flange, IDC contacts, Thermoplastic shell	Latching Non-Latching	AC3M3FPPI AC3M3FPIL



## PART NUMBER BREAKDOWN

### IDC D AND P THERMOPLASTIC CHASSIS TYPE

E. G. **AC3MDPIL-AU BULK**  
**AC** (series prefix), **3** contacts, **Male**, **D** Flange, **Plastic** Shell, **IDC**, **Latchless**,  
**- AU** (Gold Plated Contacts), **BULK** Packaged.

<b>SERIES PREFIX</b>	AC	=	Series Prefix
<b>CONTACT LAYOUT</b>	3	=	3 Contacts only
<b>GENDER</b>	F	=	Female Socket Contacts
	M	=	Male Pin Contacts
<b>SHELL STYLE</b>	D	=	D Flange
	P	=	P Flange
<b>SHELL SERIES</b>	P	=	Thermoplastic Chassis Series
<b>TERMINATION</b>	I	=	IDC Termination
<b>LOCKING MECHANISM</b>	Blank	=	Latching
	L	=	Latchless
<b>CONTACT PLATING</b>	Blank	=	Standard Plating (Silver or Tin - Refer to Standard Data.)
	AU	=	Gold Plated Contacts
<b>PACKAGING</b>	Blank	=	Individual Bags
	BULK	=	Bulk Packed

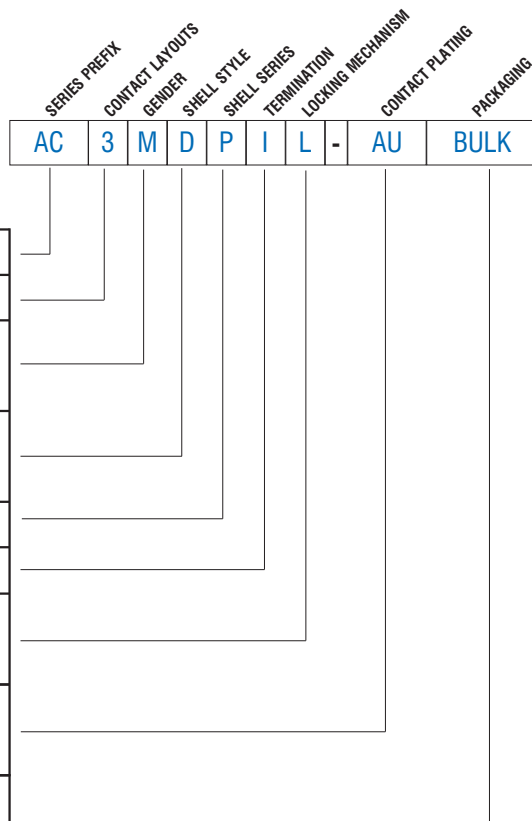

## PART NUMBER BREAKDOWN

### IDC DUAL THERMOPLASTIC CHASSIS TYPE

E. G. **AC3F3MPPIL-AU BULK**  
**AC** (series prefix), **3F**Female, **3M**Male, **PP** (Dual Thermoplastic Chassis series), **IDC**,  
**Latchless**, **- AU** (Gold Plated Contacts), **BULK** Packaged.

<b>SERIES PREFIX</b>	AC	=	Series Prefix
<b>CONTACT LAYOUT LEFT HAND SIDE<sup>3)</sup></b>	3F	=	3 Female Socket Contacts only
	3M	=	3 Male Pin Contacts only
<b>CONTACT LAYOUT RIGHT HAND SIDE<sup>3)</sup></b>	3F	=	3 Female Socket Contacts
	3M	=	3 Male Pin Contacts
<b>SHELL STYLE</b>	PP	=	Dual Thermoplastic Chassis Series
<b>TERMINATION</b>	I	=	IDC Termination
<b>LOCKING MECHANISM</b>	Blank	=	Latching
	L	=	Latchless
<b>CONTACT PLATING</b>	Blank	=	Standard Plating (Silver or Tin - Refer to Standard Data.)
	AU	=	Gold Plated Contacts
<b>PACKAGING</b>	Blank	=	Individual Bags
	BULK	=	Bulk Packed

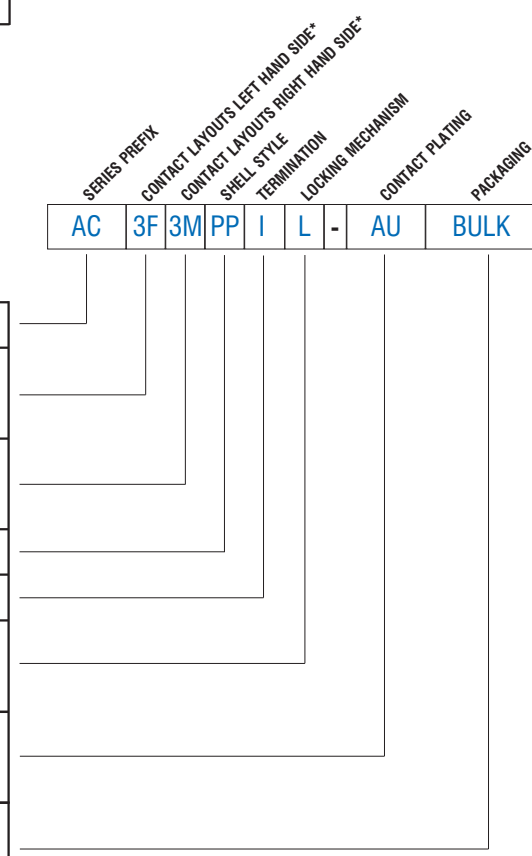

<sup>3)</sup> Viewed from front of connector.



**Features:**

- Thermoplastic Shell.
- Dual Housing.
- Solder Bucket connections.
- Vertical or Horizontal PCB mounting.
- Stamped contacts.
- Leading first mate last break socket contact.
- Positive latch lock system.
- Coloured housings available as specials.

**Options:** Solder Buckets or IDC, Vertical or Horizontal PCB, Bulk Pack, Latching or Non-latching, Gold plated contacts.

**Part Number Breakdown: Page 67 Specifications: Page 68**

**PCB Footprints: Page 69**

**Panel Cutouts: Page 69**

PRODUCT - FIGURE	DRAWING	Dimensions in mm (inches)	DESCRIPTION	VARIATIONS	PART NUMBER
		40.0 [1.575"] 26.0 [1.024"] 37.0 [1.457"] 56.6 [2.228"] 67.0 [2.638"] 4- $\varnothing$ 3.3 [0.131"] CSK 90° TD $\varnothing$ 5.7 [0.224"] 2.3 [0.091"] $\varnothing$ 23.2 [0.913"] 5.0 [0.197"] 6.2 [0.244"] 21.8 [0.858"]	XLR 3 pole male + 3 pole male, Dual Flange, Solder contacts	Latching Non-Latching	AC3M3MPP AC3M3MPPL
		40.0 [1.575"] 26.0 [1.024"] 37.0 [1.457"] 56.6 [2.228"] 67.0 [2.638"] 2.3 [0.091"] $\varnothing$ 23.2 [0.913"] 12.2 [0.480"] 2.7 [0.106"] 21.6 [0.850"]	XLR 3 pole male + 3 pole male, Dual Flange, Horizontal PCB mount	Latching Non-Latching	AC3M3MPPH AC3M3MPPHL
		40.0 [1.575"] 26.0 [1.024"] 37.0 [1.457"] 56.6 [2.228"] 67.0 [2.638"] 2.3 [0.091"] $\varnothing$ 23.2 [0.913"] 5.0 [0.197"] 15.7 [0.617"] 21.8 [0.858"]	XLR 3 pole male + 3 pole male, Dual Flange, Vertical PCB mount	Latching Non-Latching	AC3M3MPPV AC3M3MPPVL
		40.0 [1.575"] 26.0 [1.024"] 37.0 [1.457"] 56.6 [2.228"] 67.0 [2.638"] 7.0 [0.277"] 2.3 [0.091"] $\varnothing$ 23.2 [0.913"] $\varnothing$ 6.4 [0.252"] 5.0 [0.197"] $\varnothing$ 21.8 [0.858"]	XLR 3 pole female + 3 pole female, Dual Flange, Solder contacts	Latching Non-Latching	AC3F3FPP AC3F3FPPL
		40.0 [1.575"] 26.0 [1.024"] 37.0 [1.457"] 56.6 [2.228"] 67.0 [2.638"] 7.0 [0.277"] 2.3 [0.091"] $\varnothing$ 23.2 [0.913"] $\varnothing$ 21.6 [0.850"] 4.0 [0.157"] 12.2 [0.480"] $\varnothing$ 6.2 [0.242"]	XLR 3 pole female + 3 pole female, Dual Flange, Horizontal PCB mount	Latching Non-Latching	AC3F3FPPH AC3F3FPPHL





PRODUCT - FIGURE	DRAWING	Dimensions in mm (inches)	DESCRIPTION	VARIATIONS	PART NUMBER
			XLR 3 pole female + 3 pole female, Dual Flange, Vertical PCB mount	Latching	AC3F3FPPV
				Non-Latching	AC3F3FPPVL
			XLR 3 pole male + 3 pole female, Dual Flange, Solder contacts	Standard	AC3M3FPP
				Non-Latching	AC3M3FPPVL
			XLR 3 pole male + 3 pole female, Dual Flange, Horizontal PCB mount	Standard	AC3M3FPPH
				Non-Latching	AC3M3FPPHVL
			XLR 3 pole male + 3 pole female, Dual Flange, Vertical PCB mount	Standard	AC3M3FPPV
				Non-Latching	AC3M3FPPVL
			XLR 3 pole female + 3 pole male, Dual Flange, Solder contacts	Standard	AC3F3MPP
				Non-Latching	AC3F3MPPVL
			XLR 3 pole female + 3 pole male, Dual Flange, Horizontal PCB mount	Standard	AC3F3MPPH
				Non-Latching	AC3F3MPPHVL
			XLR 3 pole female + 3 pole male, Dual Flange, Vertical PCB Mount	Standard	AC3F3MPPV
				Non-Latching	AC3F3MPPVL



## PART NUMBER BREAKDOWN

### DUAL THERMOPLASTIC TYPE

E. G. **AC3M3MPPL-AU BULK**  
**AC** (Series Prefix), **3M**ale(LHS), **3M**ale(RHS), **PP** Dual Thermoplastic Chassis Series, Latchless, - **AU** (Gold Plated Contacts), **Bulk** Packaged.

<b>SERIES PREFIX</b>	AC	=	Series Prefix
<b>CONTACT LAYOUT LEFT HAND SIDE <sup>3)</sup></b>	3F	=	3 Female Socket Contacts only
	3M	=	3 Male Pin Contacts only
<b>CONTACT LAYOUT RIGHT HAND SIDE <sup>3)</sup></b>	3F	=	3 Female Socket Contacts
	3M	=	3 Male Pin Contacts
<b>SHELL STYLE</b>	PP	=	Dual Thermoplastic Chassis Series
<b>LOCKING MECHANISM</b>	Blank	=	Latching
	L	=	Latchless
<b>CONTACT PLATING</b>	Blank	=	Standard Plating (Silver or Tin - Refer to Standard Data.)
	AU	=	Gold Plated Contacts
<b>PACKAGING</b>	Blank	=	Individual Bags
	BULK	=	Bulk Packed

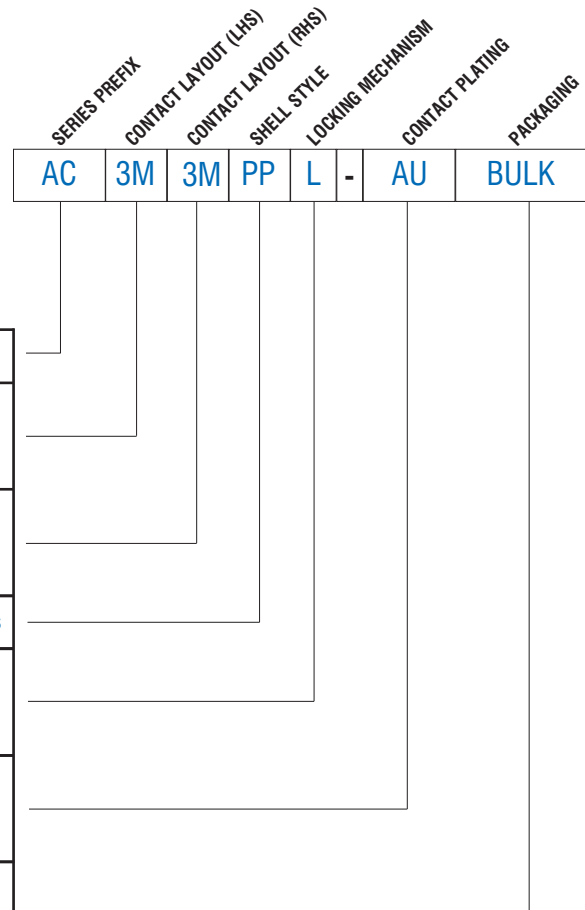

<sup>3)</sup> Viewed from front of connector.

## STANDARD DATA AC CHASSIS - THERMOPLASTIC

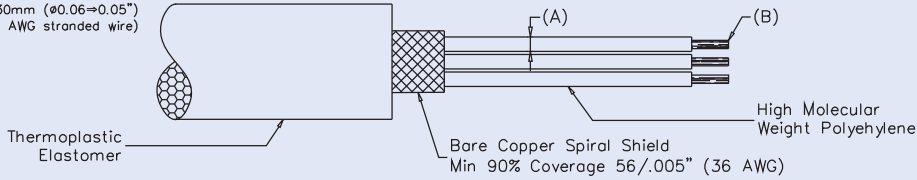
		VALUE
<b>GENERAL CHARACTERISTICS</b>	Number of contacts	3
	AC Series Contact Arrangements (Front view of pin inserts)	
	Termination	Solder / IDC / Printed Circuit Board (PCB)
	Wire Gauge - Stranded wire:	
	IDC	24AWG
	Solder	12AWG
	Printed Circuit Board (PCB)	N/A
	Flammability	UL94V-0
Environmental	Complies with RoHS Directive 2002/95/EC	
<b>ELECTRICAL CHARACTERISTICS</b>	Service Voltage RMS	133V <sup>1)</sup>
	Test Voltage AC RMS	1400V
	Current carrying capacity:	
	IDC	1A
	Solder	15A
	Printed Circuit Board (PCB)	15A
	Typical Contact Resistance	≤3mΩ
	Insulation Resistance	≥1000MΩ
<b>CLIMATIC CHARACTERISTICS</b>	Protection Class	IP40
	Operating Temperature	-25 °C to +75 °C (-13°F to +167°F)
<b>MECHANICAL CHARACTERISTICS</b>	Weight <sup>2)</sup>	14g - (0.030lb)
	Mechanical Operations	1000 mating cycles
<b>MATERIALS</b>	Connector Shell - Thermoplastic	Thermoplastic, ULV94V-0 Modified PPE Resin
	Shell Finish	Black, other colours available - contact factory
	Insulators	ULV94V-0 PBT Resin or Modified PPE Resin
	Male Contact Stamped IDC-Material/Plating Stamped Solder and PCB-Material/Plating	Phosphor Bronze / Silver or Gold (optional) Phosphor Bronze / Silver or Gold (optional)
	Female Contact Stamped IDC-Material/Plating Stamped Solder and PCB-Material/Plating	Phosphor Bronze / Tin or Gold (optional) Phosphor Bronze / Tin or Gold (optional)
<b>IDC RECOMMENDED CABLE DIMENSIONS</b>	<p>A - OD <math>\phi 1.50 \Rightarrow 1.30\text{mm}</math> (<math>\phi 0.06 \Rightarrow 0.05''</math>)            B - <math>16/.005''</math> (24 AWG stranded wire)</p>  <p>Thermoplastic Elastomer      Bare Copper Spiral Shield            Min 90% Coverage <math>56/.005''</math> (36 AWG)      High Molecular Weight Polyethylene</p>	

<sup>1)</sup> Not suitable for domestic applications above 50V

<sup>2)</sup> Approximate weight in grams does not include packaging. Please contact us for exact weight for shipping purposes.

## AC SERIES RECEPTACLES THERMOPLASTIC

### MOUNTING INFORMATION

**'D' SERIES**  
90° PCB (H)

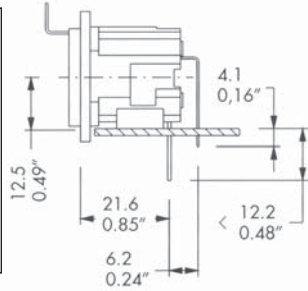
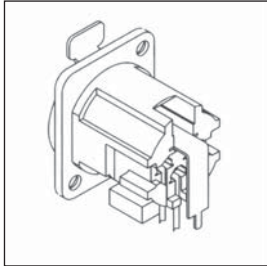

**'D' SERIES**  
STRAIGHT PCB (V)

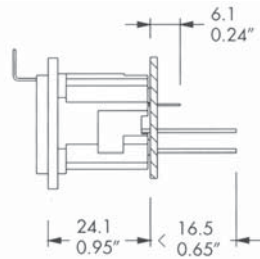
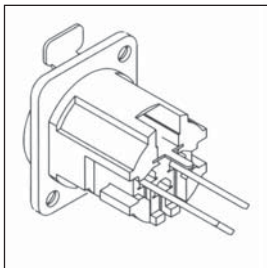

**'P' SERIES**  
90° PCB (H)

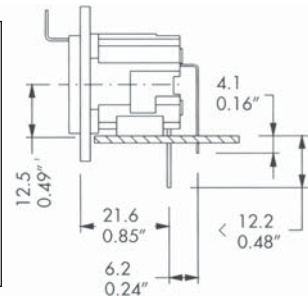
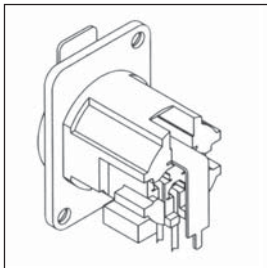

**'P' SERIES**  
STRAIGHT PCB (V)

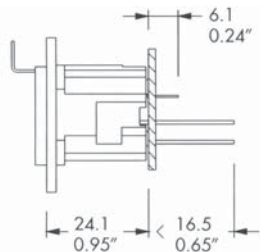
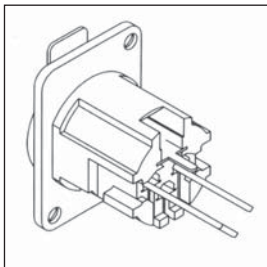

**NOTE:** For Dual Gang dimensions other than the mounting centres shown opposite please refer to the P Series above.

### PCB FOOTPRINT - CONNECTOR SIDE OF PCB

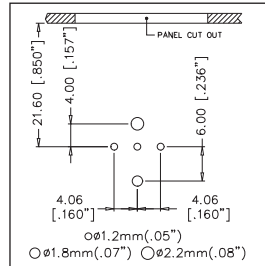

**AC3FDPH / AC3FPPH**

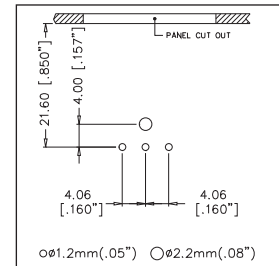

**AC3MDPH / AC3MPPH**

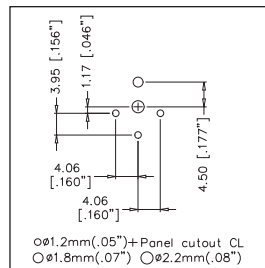

**AC3FDPV / AC3FPPV**

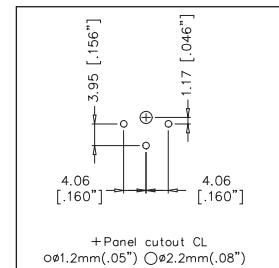

**AC3MDPV / AC3MPPV**

### PANEL CUTOUT DIMENSIONS - FRONT VIEW

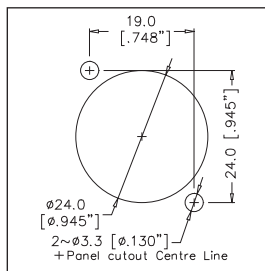

**AC3FDP / AC3MDP**

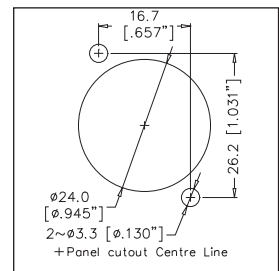

**AC3FPP / AC3MPP**

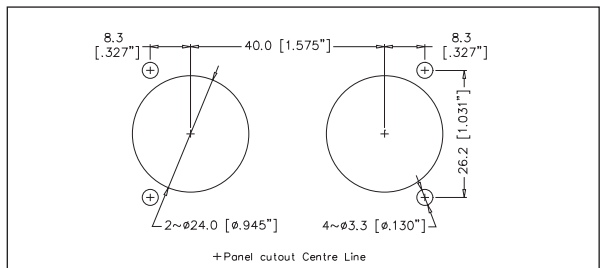

**AC DUAL GANG**

## AC IDC SERIES CHASSIS ASSEMBLY INSTRUCTIONS

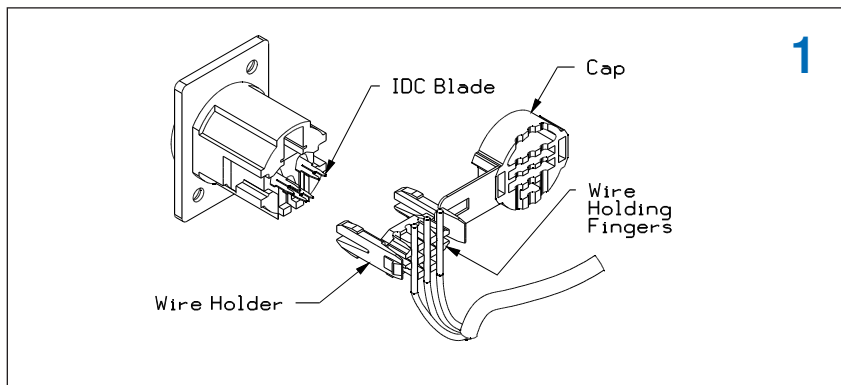

Lay the insulated conductors between the wire holding fingers. The fingers will retain the wire if it is inserted sufficiently.

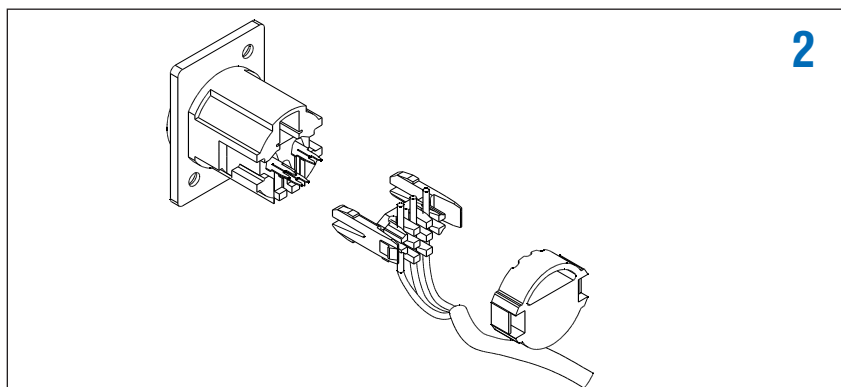

Break the strap off from the wire holder and the cap. Assemble the cap to the wire holder as shown. Push it home until the second snap operates.

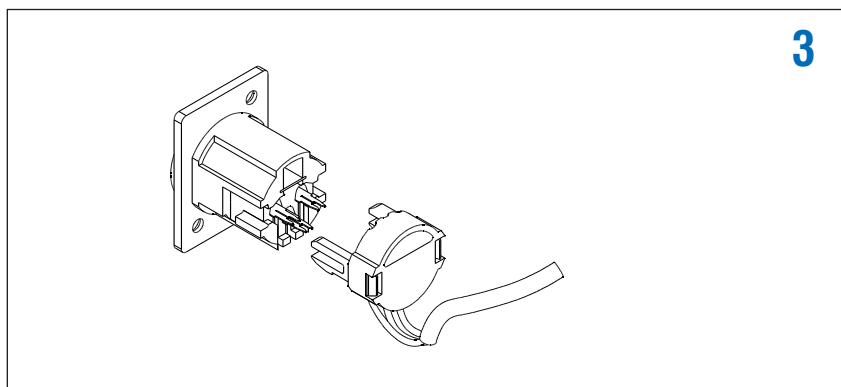

Align the wire holder and cap assembly with the slots down the side of the connector body. Push together, being careful not to damage the IDC blades through misalignment.

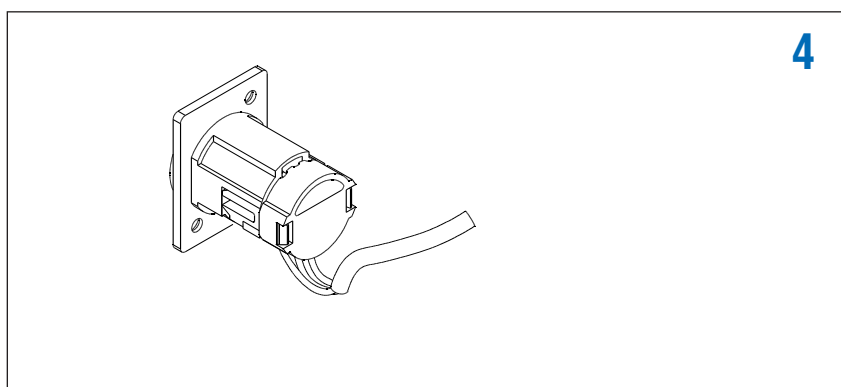

Ensure wire holder snaps into the body.

# Amphenol



This range has been specially designed for amplifier to loudspeaker connections. The polarity configuration being POSITIVE, DRAIN, NEGATIVE. Visual color coding insert with matching boot/backshell (blue or white) can be used for either channel selection and/or cable identification purposes. AC-PDN 11 & 31 are recommended for live source applications (amplifiers). AC-PDN 12 & 34 are recommended for load applications (speakers).

**Features:**

- Solder Bucket connections.
- Thermoplastic Shells
- Designed for 25 Amps RMS usage.
- “Jaws” Cable Retention System, Max. Cable O.D. 8mm (0.351”)
- Precision machined contacts accept up to 4mm<sup>2</sup> (12AWG) conductors.
- Quick and easy assembly – by hand or portable termination tool (Part Number T2860.)

**Options:** White or Blue housing and insert colour. Std. Jaws cable clamp.  
**Specifications:** [Page 72](#) [Panel Cutouts:](#) [Page 33](#)

PRODUCT - FIGURE	DRAWING Dimensions in mm (inches)	DESCRIPTION	VARIATIONS	PART NUMBER
		PDN male, Cable connector, Positive, Negative, Drain contacts, Thermoplastic shell, Large Jaws cable clamp	Blue housing  White housing	AC-PDN-12-BLU  AC-PDN-12-WHT
		PDN female, Cable connector, Positive, Negative, Drain contacts, Thermoplastic shell, Large Jaws cable clamp	Blue housing  White housing	AC-PDN-11-BLU  AC-PDN-11-WHT
		PDN male, Chassis mount, Positive, Negative, Drain contacts, Thermoplastic shell	Blue housing  White housing	AC-PDN-34-BLU  AC-PDN-34-WHT
		PDN female, Chassis mount, Positive, Negative, Drain contacts, Thermoplastic shell	Blue housing  White housing	AC-PDN-31-BLU  AC-PDN-31-WHT





# Amphenol

## STANDARD DATA AC-PDN CONNECTORS

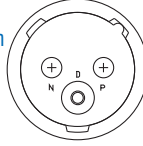
		VALUE
<b>GENERAL CHARACTERISTICS</b>	Number of contacts	2+Drain
	PDN Contact Arrangement (Front View of Socket & Pin Insert)	<div style="display: flex; justify-content: space-around; align-items: center;"> <div style="text-align: center;">  <p>Socket</p> </div> <div style="text-align: center;">  <p>Pin</p> </div> </div>
	Termination	Solder
	Max. Wire Gauge - Stranded wire:	
	Power	12AWG
	Drain	19AWG
Flammability rating of plastics	UL94V-0	
Environmental	Complies with RoHS Directive 2002/95/EC	
<b>ELECTRICAL CHARACTERISTICS</b>	Service Voltage RMS	133V <sup>1)</sup> <b>NOTE:</b> Do not use this series of connectors for mains applications. The drain contact dimensions make it unsuitable for use as an earth contact.
	Test Voltage AC RMS	1400V
	Current carrying capacity:	7.5A
	Typical Contact Resistance	≤3mΩ
	Insulation Resistance	≥1GΩ
<b>CLIMATIC CHARACTERISTICS</b>	Protection Class	IP40
	Operating Temperature	-25 °C to +75 °C (-13°F to +167°F)
<b>MECHANICAL CHARACTERISTICS</b>	Insertion and Withdrawal Force	≥10N - ≤30N
	Weight - Thermoplastic <sup>2)</sup>	19g (0.041lb)
	Typical Cable Retention Force	22Kg to 44Kg (50lb to 100lb)
	Cable O.D. Range - JAWS Clamp	6.5 mm to 8mm (0.255" to 0.314") - Standard 3 mm to 6.5 mm (0.118" to 0.255") - Optional - Contact us
	Mechanical Operations	1000 mating cycles
<b>MATERIALS</b>	Connector Shell	Thermoplastic, UL94V-0 Modified PPE Resin
	Shell Colour	Black
	Insulators	UL94V-0 PBT Resin or Modified PPE Resin
	Contact	Brass
	Contact Plating	Silver or Gold (optional)

<sup>1)</sup> Not suitable for domestic applications above 50V

<sup>2)</sup> Approximate weight only, does not include packaging. Please contact us for exact weight for shipping purposes.



## EP / AP SERIES HIGH POWER CONNECTORS

The EP Series incorporates a rugged zinc diecast shell to give it maximum durability when used in demanding situations. The EP cable connector cable flex relief design minimises cable bend stress at point of entry into the connector housing.

The AP Series Shell is manufactured from tough, durable thermoplastic, and ideal for fixed indoor installations. Both the EP and AP Series utilise the same contact and insulator components.

### Features

- High current contacts for distortion free signal.
- Tough, durable zinc diecast shell for the EP series.
- Cost effective durable thermoplastic shell for the AP series.
- EP series available in 3, 4, 5, 6 and 8 contact arrangements
- AP series available in 4, 5, 6, and 8 contact arrangements.
- Cable clamp capable of supporting cables from 9mm (0.35") to 16mm (0.63") in diameter.
- Quick release, vibration resistant latch lock.
- AP & EP Series are completely intermatable.

### Options

- Solder Bucket termination
- Nickel Plated Zinc Alloy shell
- Black finished Zinc Alloy shell
- Precision machined contacts
- Thermoplastic shell

### Ordering Codes

We have listed the more common ordering codes in each section. Please contact us if you need any further assistance.

### Simple steps to guide you in using this catalogue

- 1) Identify the product group listed in Contents on Page 1 and go directly to that page number.
- 2) Each product group cover page then details information and options available.
- 3) Refer to the product detail pages and identify the product you require pictorially.
- 4) Read the product description column for the products standard features.
- 5) Use variations column to determine your choice.
- 6) Identify part number.
- 7) In the event the particular option you require is not listed please refer to the part number breakdown page at the end of each section.
- 8) Please contact us directly if you have any further problems.







The EP Series has set the standard in high performance speaker connectors. Apart from its durability and strength, it offers consistent superior power handling capabilities.

**Features:**

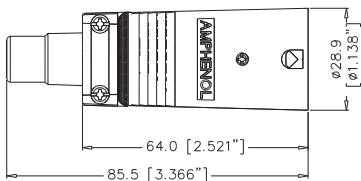
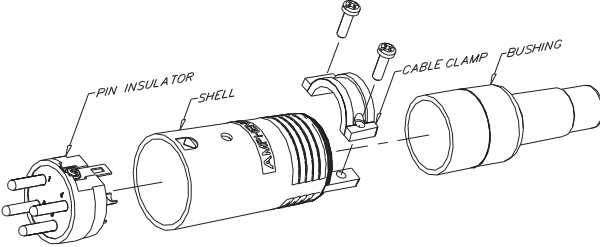

- Solder Bucket connections.
- Precision machined contacts.
- Diecast Metal Housings
- High current contacts
- Male and female cable and chassis connectors available.

**Options:** Black Finish Shell.  
**Panel Cutouts:** Page 78

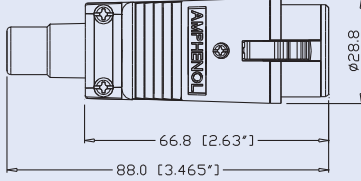
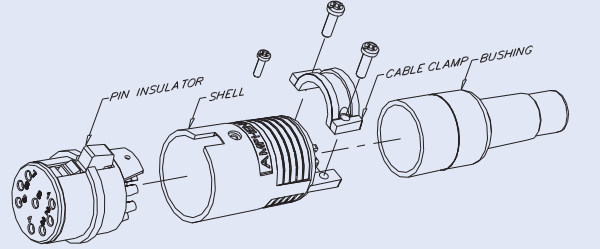
**Specifications:** Page 77-78

PRODUCT - FIGURE	DRAWING	DESCRIPTION	VARIATIONS	PART NUMBER
 <p><b>ISO ASSEMBLY OF EP MALE</b></p>	 	<p>EP Male cable connector, Machined contacts, Metal Shell</p>	3 pole nickel finish	EP-3-12
			3 pole black finish	EP-3-12B
			4 pole nickel finish	EP-4-12
			4 pole black finish	EP-4-12B
			5 pole nickel finish	EP-5-12
			5 pole black finish	EP-5-12B
			6 pole nickel finish	EP-6-12
			6 pole black finish	EP-6-12B
			8 pole nickel finish	EP-8-12
8 pole black finish	EP-8-12B			
 <p><b>ISO ASSEMBLY OF EP FEMALE</b></p>	 	<p>EP Female cable connector, Machined contacts, Metal Shell</p>	3 pole nickel finish	EP-3-11P
			3 pole black finish	EP-3-11PB
			4 pole nickel finish	EP-4-11P
			4 pole black finish	EP-4-11PB
			5 pole nickel finish	EP-5-11P
			5 pole black finish	EP-5-11PB
			6 pole nickel finish	EP-6-11P
			6 pole black finish	EP-6-11PB
			8 pole nickel finish	EP-8-11P
8 pole black finish	EP-8-11PB			

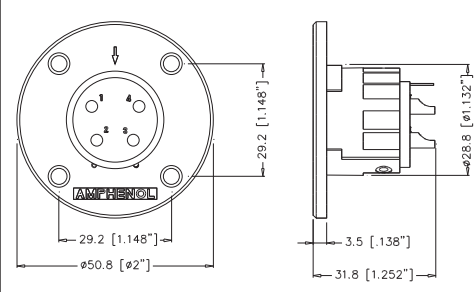

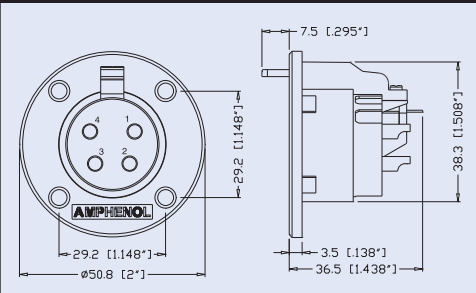
PRODUCT - FIGURE	DRAWING	DESCRIPTION	VARIATIONS	PART NUMBER
	<p style="text-align: center;">Dimensions in mm (inches)</p> 	<p>EP Male chassis mount, Round Flange, Machined contacts, Metal Shell</p>	3 pole nickel finish	EP-3-14
			3 pole black finish	EP-3-14B
			4 pole nickel finish	EP-4-14
			4 pole black finish	EP-4-14B
			5 pole nickel finish	EP-5-14
			5 pole black finish	EP-5-14B
			6 pole nickel finish	EP-6-14
			6 pole black finish	EP-6-14B
			8 pole nickel finish	EP-8-14
			8 pole black finish	EP-8-14B
		<p>EP Female chassis mount, Round Flange, Machined contacts, Metal Shell</p>	3 pole nickel finish	EP-3-13P
			3 pole black finish	EP-3-13PB
			4 pole nickel finish	EP-4-13P
			4 pole black finish	EP-4-13PB
			5 pole nickel finish	EP-5-13P
			5 pole black finish	EP-5-13PB
			6 pole nickel finish	EP-6-13P
			6 pole black finish	EP-6-13PB
			8 pole nickel finish	EP-8-13P
			8 pole black finish	EP-8-13PB





The AP Series provides the same power handling performance as the EP Series in a cost effective, yet durable Thermoplastic housing.

**Features:**

- Solder Bucket connections.
- Precision machined contacts.
- Thermoplastic Housings
- High current contacts
- Male & Female Cable and Chassis connectors available.

**Specifications: Page 77-78**

**Panel Cutouts: Page 78**

PRODUCT - FIGURE	DRAWING	Dimensions in mm (inches)	DESCRIPTION	VARIATIONS	PART NUMBER
		28.8 [1.135"] 100.0 [3.937"]	AP Male cable connector, Machined contacts, Thermoplastic Black shell.	4 pole 5 pole 6 pole 8 pole	AP-4-12 AP-5-12 AP-6-12 AP-8-12
		28.8 [1.132"] 98.7 [3.886"]	AP Female cable connector, Machined contacts, Thermoplastic Black shell.	4 pole 5 pole 6 pole 8 pole	AP-4-11 AP-5-11 AP-6-11 AP-8-11
		29.2 [1.15"] 432.4 [17.02"] 50.8 [2"] 29.2 [1.15"] 31.8 [1.252"]	AP Male chassis mount, Round Flange, Machined contacts, Thermoplastic Black shell.	4 pole 5 pole 6 pole 8 pole	AP-4-14 AP-5-14 AP-6-14 AP-8-14
		29.2 [1.148"] 432.4 [17.02"] 50.8 [2"] 29.2 [1.148"] 36.5 [1.438"]	AP Female chassis mount, Round Flange, Machined contacts, Thermoplastic Black shell.	4 pole 5 pole 6 pole 8 pole	AP-4-13 AP-5-13 AP-6-13 AP-8-13
		29.2 [1.148"] 432.4 [17.02"] 50.0 [1.969"] 40.0 [1.575"] 29.2 [1.148"] 31.8 [1.252"]	AP Male chassis mount, Rectangular Flange, Machined contacts, Thermoplastic Black shell.	4 pole 5 pole 6 pole 8 pole	AP-4-22 AP-5-22 AP-6-22 AP-8-22
		29.2 [1.148"] 432.4 [17.02"] 50.0 [1.969"] 40.0 [1.575"] 29.2 [1.148"] 36.5 [1.438"]	AP Female chassis mount, Rectangular Flange, Machined contacts, Thermoplastic Black shell.	4 pole 5 pole 6 pole 8 pole	AP-4-21 AP-5-21 AP-6-21 AP-8-21

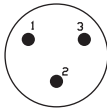
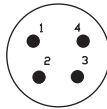
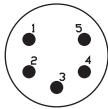
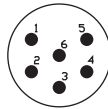
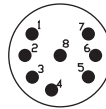

## STANDARD DATA EP/AP

		VALUE				
<b>GENERAL CHARACTERISTICS</b>	Number of contacts	3	4	5	6	8
	Contact Arrangements (Front view of pin insert)					
	Termination	SOLDER				
	Wire Gauge - Stranded wire:	12AWG	12AWG	12AWG	12AWG	14AWG
	Flammability	UL94V-0				
	Environmental	Complies with RoHS Directive 2002/95/EC				
<b>ELECTRICAL CHARACTERISTICS</b>	Service Voltage RMS <sup>1)</sup>	460V	660V	200V	200V	100V
	Test Voltage AC RMS	2400V	3000V	1600V	1600V	1300V
	Current carrying capacity	20A	20A	20A	20A	15A
	Typical Contact Resistance	≤3mΩ				
	Insulation Resistance	≥1000MΩ				
<b>CLIMATIC CHARACTERISTICS</b>	Protection Class	IP40				
	Operating Temperature	-25 °C to +75 °C (-13°F to +167°F)				
<b>MECHANICAL CHARACTERISTICS</b>	Weight - EP 11 & 12 <sup>2)</sup>	80g (0.176lb)	84g (0.185lb)	86g (0.189lb)	86g (0.189lb)	86g (0.189lb)
	Weight - EP 13 & 14 <sup>2)</sup>	48g (0.105lb)	50g (0.110lb)	54g (0.119lb)	54g (0.119lb)	54g (0.119lb)
	Weight - AP 11 & 12 <sup>2)</sup>	N/A	42g (0.092lb)	44g (0.097lb)	44g (0.097lb)	44g (0.097lb)
	Weight - AP 13, 14, 21 & 22 <sup>2)</sup>	N/A	26g (0.057lb)	30g (0.066lb)	30g (0.066lb)	28g (0.061lb)
	Typical Cable retention force	22Kg to 44Kg (50lb to 100lb) - Dependant on cable material and diameter				
	Mechanical operations	1000 mating cycles				

<sup>1)</sup> Not suitable for domestic applications above 50V

<sup>2)</sup> Approximate weight only, does not include packaging. Please contact us for exact weight for shipping purposes.





## STANDARD DATA EP/AP (CONT'D)

MATERIALS		DETAILS	
		AP	EP
Connector shell		Modified PPE Resin	Diecast Zinc Alloy
Shell finish		Black	Satin Nickel or Black
Insulators		UL94V-0 PBT Resin	
Cable Bushing		Silicon Rubber	UL94 HB Thermoplastic Elastomer
Male contact Machined - Solder		Brass / Bright Tin	
Material / Plating			
Female contact Machined - Solder		Brass / Bright Tin	
Material / Plating			
CLAMPING CHARACTERISTICS	Cable OD Range	11mm to 17mm (0.43" to 0.67")	9mm to 16mm (0.35" to 0.63")
	Retention Method	Two opposing plastic screws	Metal saddle clamp



## EP/AP SERIES PANEL CUTOUT DATA - FRONT VIEW

EP 13/AP 13/AP 21

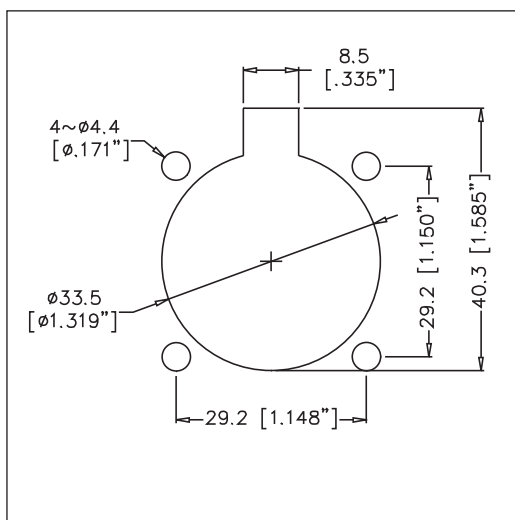

EP 14/AP 14/AP 22

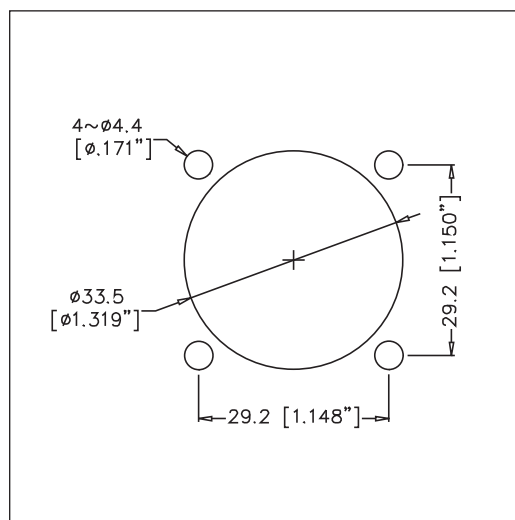

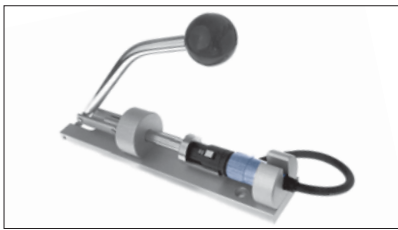







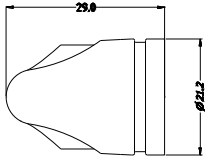

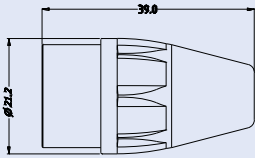

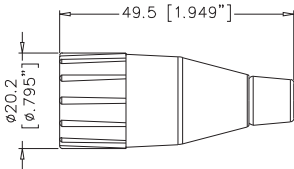

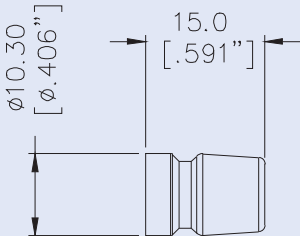
- Colour coded boots(backshells) and rings to assist in cable identification.
- In-line adaptors. Pre-wired for convenience.
- Termination tool for fast assembly of cable connectors.
- Mounting hardware.
- Metal boots(backshells) for rugged environments.

PRODUCT - FIGURE	DRAWING	DESCRIPTION	VARIATIONS	PART NUMBER
		XLR 3 pole male to 3 pole male adapter, Pre wired, Metal Shell	Nickel Finish Black Finish	AC3M3MW AC3M3MBW
		XLR 3 pole female to 3 pole female adapter, Pre wired, Metal Shell	Nickel Finish Black Finish	AC3F3FW AC3F3FBW
		XLR 3 pole female to 3 pole male adapter, Pre wired, Metal Shell	Nickel Finish Black Finish	AC3F3MW AC3F3MBW
		XLR 3 pole female to 5 pole male adapter, Pre wired, Metal Shell	Nickel Finish	AC3F5MW
		XLR 3 pole male to 5 pole female adapter, Pre wired, Metal Shell	Nickel Finish	AC3M5FW
		XLR 5 pole male to 5 pole male adapter, Pre wired, Metal Shell	Nickel Finish	AC5M5MW
		Termination Tool	For IDC and Solder cable connectors	T2860
N / A	N / A	Termination Tool	For AC Series Right Angle cable connectors	T2880
N / A	N / A	Termination Tool	For AX Series cable connectors	T2890
N / A		A Type / C Type Connector Mounting, Self-Tapping Screw	2.9 x 1.06 Tri-rondular	52500002-734
N / A		B Type Connector Mounting, Self-Tapping Screw	M2.5	52500005-732

ACC.

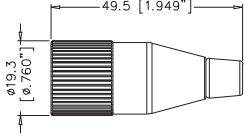
PRODUCT - FIGURE	DRAWING Dimensions in mm (inches)	DESCRIPTION	VARIATIONS	PART NUMBER
		AX Series Coloured Sleeve	Brown	AX-SLEEVE-1
			Red	AX-SLEEVE-2
			Orange	AX-SLEEVE-3
			Yellow	AX-SLEEVE-4
			Green	AX-SLEEVE-5
			Blue	AX-SLEEVE-6
			Violet	AX-SLEEVE-7
			Grey	AX-SLEEVE-8
			White	AX-SLEEVE-9
			Black	AX-SLEEVE
Clear	AX-SLEEVE-C			
		AX Series Coloured Boot	Brown	AX-BOOT-1
			Red	AX-BOOT-2
			Orange	AX-BOOT-3
			Yellow	AX-BOOT-4
			Green	AX-BOOT-5
			Blue	AX-BOOT-6
			Violet	AX-BOOT-7
			Grey	AX-BOOT-8
			White	AX-BOOT-9
			Black	AX-BOOT
Clear	AX-BOOT-CLR			
		AC Coloured Boot / Backshell  <b>Note:</b> Number Identification optional. (Please contact us.)	Brown	AC-NUT-BRN
			Red	AC-NUT-RED
			Orange	AC-NUT-ORG
			Yellow	AC-NUT-YEL
			Green	AC-NUT-GRN
			Blue	AC-NUT-BLU
			Violet	AC-NUT-VIO
			Grey	AC-NUT-GRY
			White	AC-NUT-WHT
				
Red	AC-GROMMET-RED			
Orange	AC-GROMMET-ORG			
Yellow	AC-GROMMET-YEL			
Green	AC-GROMMET-GRN			
Blue	AC-GROMMET-BLU			
Violet	AC-GROMMET-VIO			
Grey	AC-GROMMET-GRY			
White	AC-GROMMET-WHT			

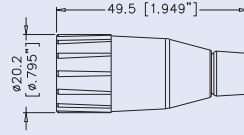
ACC.

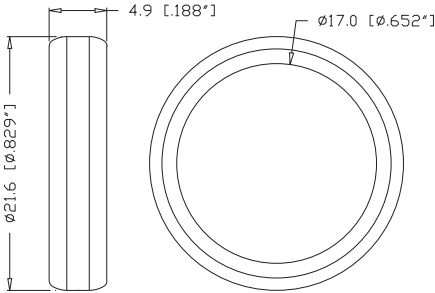
PRODUCT - FIGURE	DRAWING Dimensions in mm (inches)	DESCRIPTION	VARIATIONS	PART NUMBER
		AC Metal Boot / Backshell, Black Finish	Not Applicable	AC-NUT-METAL
		AC Thermoplastic Boot / Backshell. Suitable for use with 8.5mm (0.33") O.D. cable.	Not Applicable	AC-NUT-J-BLK
		AC Coloured Identification Rings – Plain and Numbered	<ul style="list-style-type: none"> <li>Brown</li> <li>Red</li> <li>Orange</li> <li>Yellow</li> <li>Green</li> <li>Blue</li> <li>Violet</li> <li>Grey</li> <li>White</li> <li>Red #1-24</li> <li>Yellow #1-24</li> <li>Blue #1-24</li> <li>Red #1-48</li> <li>Yellow #1-48</li> <li>Blue #1-48</li> </ul>	<ul style="list-style-type: none"> <li>AC-RING-BRN</li> <li>AC-RING-RED</li> <li>AC-RING-ORG</li> <li>AC-RING-YEL</li> <li>AC-RING-GRN</li> <li>AC-RING-BLU</li> <li>AC-RING-VIO</li> <li>AC-RING-GRY</li> <li>AC-RING-WHT</li> <li>AC-RING-RED-PK1</li> <li>AC-RING-YEL-PK1</li> <li>AC-RING-BLU-PK1</li> <li>AC-RING-RED-PK2</li> <li>AC-RING-YEL-PK2</li> <li>AC-RING-BLU-PK2</li> </ul>

**Note:** Custom number Identification optional. (Please contact us.)

NOTE: All accessories comply with RoHS Directive 2002/95/EC

NOTE: Please do not refer to this printed catalogue as a colour reference. For exact colours contact your sales representative.



## BNC 75 RF CONNECTORS

Within the internationally standardised BNC mating face dimensions, a perfect 75 ohm characteristic impedance cannot be realised. However, at frequencies up to 1000 MHz, the small impedance deviation is negligible for practical applications. Our true 75 ohm connectors with a typical VSWR reading of 1.06:1 at 2000 MHz are identified by an asterisk following the part number.

### Applications

- Broadcast
- High bandwidth video equipment
- D1/D2 serial digital
- Graphic work stations
- Telephony / Workstations

### Options

- Crimp Plugs
- Jack to Jack adapters
- Patch Panels
- 'D' Shell Jacks
- Plug to Plug U-Link connectors
- Crimp Tools

### Ordering Codes

We have listed the more common ordering codes in each section. Amphenol offer an extensive range of RF connectors for most applications.

Please visit [www.amphenolconnex.com](http://www.amphenolconnex.com) for further information. Please contact us if you need any further assistance.

### Simple steps to guide you in using this catalogue

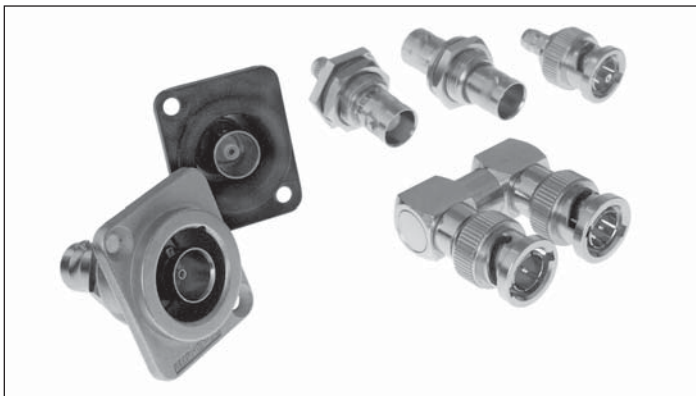

- 1) Identify the product group listed in Contents on Page 1 and go directly to that page number.
- 2) Each product group cover page then details information and options available.
- 3) Refer to the product detail pages and identify the product you require pictorially.
- 4) Read the product description column for the products standard features.
- 5) Use variations column to determine your choice.
- 6) Identify part number.
- 7) In the event the particular option you require is not listed please refer to the part number breakdown page at the end of each section.
- 8) Please contact us directly if you have any further problems.



Amphenol manufactures a large range of connectors to suit cables other than those listed below, for example Belden YR23769 and 46899, please contact us to discuss your specific requirements.

The complete Amphenol Connex catalogue featuring a wide range of RF connector products is available on request. Item code CAT-CONNEX-01.

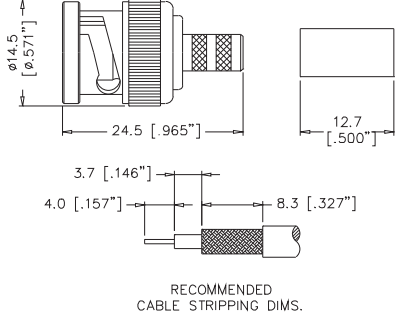

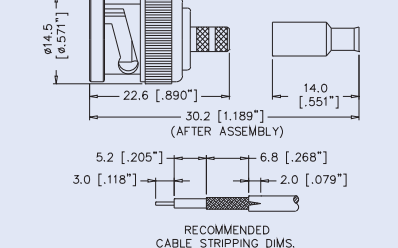







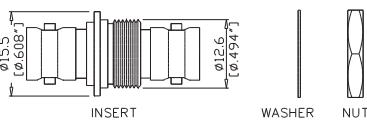

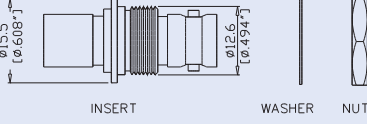

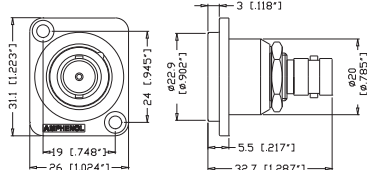

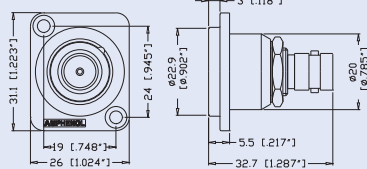
T1 connectors 0-4GHz are available on request.

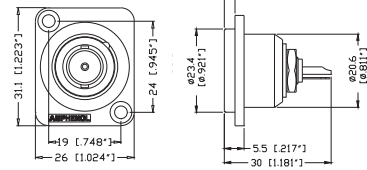
PRODUCT - FIGURE	DRAWING Dimensions in mm (inches)	CABLE TYPE RG-/U	INSULATION	CRIMP TOOL	PART NUMBER
		59/ 62/ 140/ 210	Delrin	A	112119
			Teflon	A	112952*
		59/ U-20AWG	Delrin	A	112507
			Teflon	A	112956*
		11/ U-14AWG/ B8213/ B9292/ B7731/ B1859A	Teflon	D	112606
		6/ 143/ 212	Delrin	E	112508
		B1694A/ B9248	Delrin	E	112565
			Teflon	H	112957*
		6 PLENUM/ B1695A	Delrin	E	112519
		B8281/ B9231/ B9141	Delrin	E	112509
			Teflon	E	112953*
		B1505A	Teflon	A	112951*
B735A1	Teflon	B	112950*		
		179/ 187/ B9221	Delrin	B	112133
		180/ 195/ 122/ B8218/ B1865A/ B1855	Delrin	B	112521
			Teflon	B	112955*

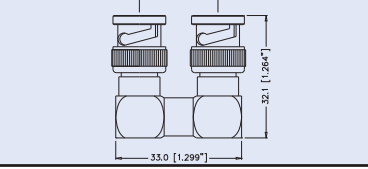

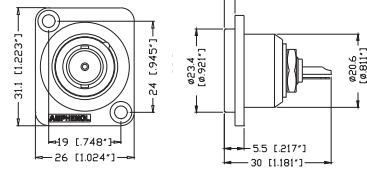
**Note:** \*Centre contact .053" diameter, 30u" Au. True 75 ohm. Use .044 hex or 12 indent crimp part 47009.

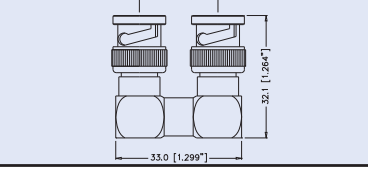

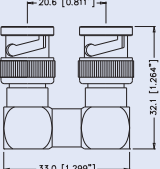

PRODUCT - FIGURE	DRAWING Dimensions in mm (inches)	DESCRIPTION & CABLE TYPE RG-/U	INSULATION	CRIMP TOOL	PART NUMBER
		<b>Bulkhead Adapter -Isolated</b> Jack to Jack - Straight Bayonet Lock to Bayonet Lock	Teflon	N/A	AC-BNC-JJA-75
		<b>Bulkhead Adapter -Isolated</b> Jack to Jack - Straight Push on to Bayonet Lock	Teflon	N/A	AC-BNC-PJA-75
		<b>Bulkhead Adapter -Isolated, 'D' Shell Housing</b> Jack to Jack, Bayonet Lock to Bayonet Lock, Nickel Finish	Teflon	N/A	AC - BNC - JJ - 75
		<b>Bulkhead Adapter -Isolated, 'D' Shell Housing</b> Jack to Jack, Bayonet Lock to Bayonet Lock, Black Finish	Teflon	N/A	AC - BNC - JJ - 75B
		<b>Bulkhead Adapter -Isolated, 'D' Shell Housing</b> Jack to Jack, Push on to Bayonet Lock, Nickel Finish	Teflon	N/A	AC - BNC - PJ - 75
		<b>Bulkhead Adapter -Isolated, 'D' Shell Housing</b> Jack to Jack, Push on to Bayonet Lock, Black Finish	Teflon	N/A	AC - BNC - PJ - 75B
		<b>Bulkhead Receptacle -Isolated, 'D' Shell Housing</b> Jack to Solder Bucket with Ground Tag, Nickel Finish	Nylon	N/A	AC - BNC - JS-75
		<b>Bulkhead Receptacle -Isolated, 'D' Shell Housing</b> Jack to Solder Bucket with Ground Tag, Black Finish	Nylon	N/A	AC - BNC - JS-75B
		<b>U - Link</b> Centre to Centre - 20.6 mm  <b>Note:</b> Custom Sizes available please contact factory.	Teflon	N/A	BNC - U-LINK 75*1

## BNC 75 RF ACCESSORIES AND TOOLING

PRODUCT - FIGURE	DESCRIPTION	DIE CAVITIES	CABLE TYPE RG-/U	CONNECTOR GUIDE	PART NUMBER
	Crimp tool with Die Set	.255 / .213 / .068	59 / 62	A	47-10070
		.178 / .128 / .068	179 / 187 / 180 / 195	B	47-10150
		.429 / .100 / .080	11	D	47-10090
		.324 / .255 / .068 / .042	6 / 59 / B8281	E	47-10110
		.350 / .320 / .255	RG59	H	47-10100
		.324 / .178 / .068	6 / 179 / 187	K	47-10200
		.255 / .178 / .068 / .052	59 / 62 / 179 / 187	M	47-10220
		.278 / .255 / .068 / .042	B1505A / B1694A	N	47-10240
	12-Way indent crimp tool	This 12 point, full ratchet crimp tool terminates precision BNC, .053 diameter, 75 centre contacts, as specified in this catalogue. Tool is designed for Telco/Broadcast applications and is built to M22520 specifications.		True 75 ohm	47009

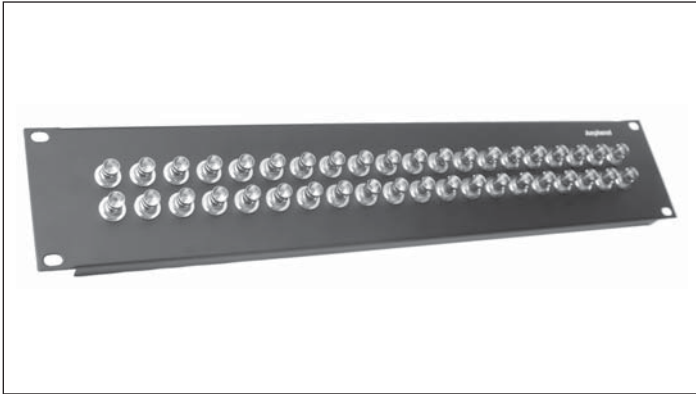



**Features:**

- Amphenol 75 connectors
- Bayonet lock or Push-on types
- Supplied with adhesive strip ID labels

**Options:**

- 1RU, 20 BNC connectors or 2RU, 40 BNC connectors
- Aluminium in Clear or Black anodised
- Steel in Black powder coat
- Customised versions available on request

PRODUCT - FIGURE DRAWING	Dimensions in mm (inches)	DESCRIPTION	MATERIAL / FINISH	LOADED WITH <small>(refer to page 63 for specifications)</small>	PART NUMBER
 		1RU 1X20 Patch Panel, Supplied with 1 ID label	Steel / Black	Empty Panel	AC-BNC20M
			Steel / Black	AC-BNC-JJA-75	AC-BNC20MJ75
			Steel / Black	AC-BNC-PJA-75	AC-BNC20MP75
			Aluminium / Clear	Empty Panel	AC-BNC20A
			Aluminium / Clear	AC-BNC-JJA-75	AC-BNC20AJ75
			Aluminium / Clear	AC-BNC-PJA-75	AC-BNC20AP75
			Aluminium / Black	Empty Panel	AC-BNC20B
			Aluminium / Black	AC-BNC-JJA-75	AC-BNC20BJ75
			Aluminium / Black	AC-BNC-PJA-75	AC-BNC20BP75
 		2RU 2X20 Patch Panel, Supplied with 2 ID labels	Steel / Black	Empty Panel	AC-BNC40M
			Steel / Black	AC-BNC-JJA-75	AC-BNC40MJ75
			Steel / Black	AC-BNC-PJA-75	AC-BNC40MP75
			Aluminium / Clear	Empty Panel	AC-BNC40A
			Aluminium / Clear	AC-BNC-JJA-75	AC-BNC40AJ75
			Aluminium / Clear	AC-BNC-PJA-75	AC-BNC40AP75
			Aluminium / Black	Empty Panel	AC-BNC40B
			Aluminium / Black	AC-BNC-JJA-75	AC-BNC40BJ75
			Aluminium / Black	AC-BNC-PJA-75	AC-BNC40BP75
		Panel ID label	Plastic	Not Applicable	AC-BNC-LABEL



## BNC 75 RF ASSEMBLY INSTRUCTIONS

### ASSEMBLY A

#### STEP 1

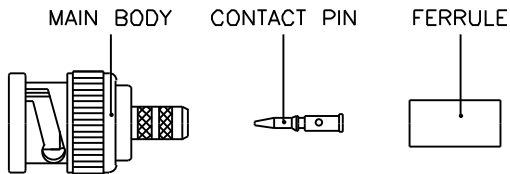

#### STEP 2

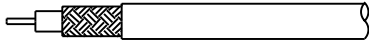

#### STEP 3

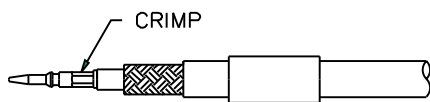

#### STEP 4

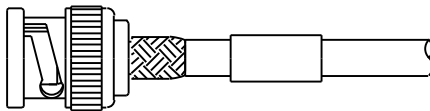

#### STEP 5

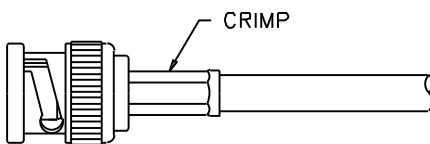

STEP 1. All parts of the connector are shown. A crimp tool is necessary to complete the connection.

STEP 2. Strip the cable inner conductor, dielectric, braid, and jacket as per "RECOMMENDED CABLE STRIPPING DIM'S" in catalogue.

STEP 3. Insert inner conductor into the CONTACT PIN, crimp it with the crimp tool as shown. Then slide the FERRULE onto cable.

STEP 4. Insert the MAIN BODY into braid and dielectric.

STEP 5. Slide the FERRULE over braid, crimp it with the crimp tool as shown.

### ASSEMBLY B

#### STEP 1

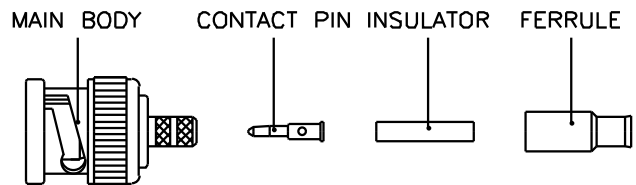

#### STEP 2

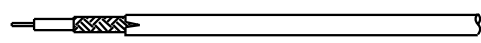

#### STEP 3

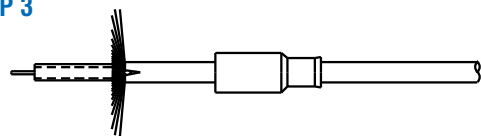

#### STEP 4

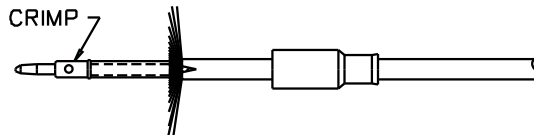

#### STEP 5

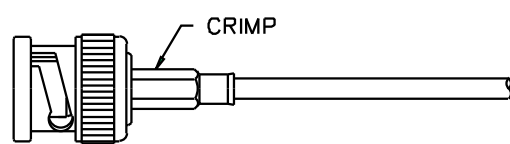

STEP 1. All parts of the connector are shown. A crimp tool is necessary to complete the connection.

STEP 2. Strip the inner conductor, dielectric, and jacket as per "RECOMMENDED CABLE STRIPPING DIM'S" in catalogue.

STEP 3. Slide the FERRULE on to cable, then fold back braid wire and slide the INSULATOR on to dielectric as shown.

STEP 4. Insert inner conductor into the CONTACT PIN, crimp it with crimp tool as shown.

STEP 5. Push cable and parts into the MAIN BODY until it stops. Then slide the FERRULE over braid wire and against the MAIN BODY, crimp it with the crimp tool as shown.



## STANDARD DATA BNC 75 RF CONNECTORS

		VALUE	
<b>GENERAL CHARACTERISTICS</b>	Mating	Bayonet Lock	
	Cable Attachment	Crimp - Crimp	
	Environmental	Complies with RoHS Directive 2002/95/EC	
<b>ELECTRICAL CHARACTERISTICS</b>	Impedance	75	
	Frequency Range	0 - 1 GHz	
	Voltage Rating	500V RMS	
	Dielectric withstanding voltage	1500 Volts RMS	
	VSWR	1.05+0.1f(GHz) DC to 1 GHz	
	Contact Resistance		
	Centre Contact	1.5 milliohm	
	Outer Contact	1.0 milliohm	
Insulation Resistance	5000 MΩ (min.)		
<b>MATERIALS</b>	<b>Part</b>	<b>Material</b>	<b>Finish</b>
	Body, Coupling sleeves	Brass	Nickel
	Crimp Ferrule	Annealed Copper	Nickel
	Male Contact	Brass	Gold
	Female Contact	Beryllium Copper or Phosphor Bronze	Gold
	XLR Housing	Diecast Zinc Alloy	Satin Nickel or Black Polyester
	Insulators	Teflon or Delrin	Natural

**NOTE:** These characteristics are typical and may not apply to all connectors.

## PANEL CUTOUTS - FRONT VIEW

AC-BNC-PJ-75  
AC-BNC-JJ-75

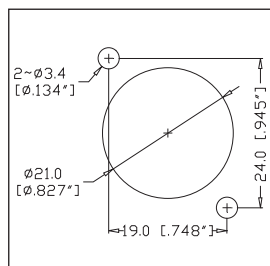

AC-BNC-PJA-75  
AC-BNC-JJA-75

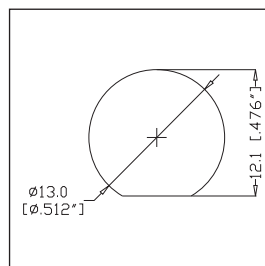



## 1/4" PHONE CONNECTORS

Amphenol has introduced two ranges of 1/4" Phone plug connectors to satisfy the needs of the manufacturer and the end user. The PRO – a heavy duty on-road plug and the MUSICIAN - a solid performing general use plug. Both series offer different features and benefits and the most suitable type will be determined by application, budget and personal choice. The 1/4" Phone plug jacks range has been widened with the stackable (piggy back) OEM series, saving board space and manufacturing costs.

### Applications

- Audio Cables and Snakes
- Amplifiers
- Speakers
- Mixing desks
- Rack mount equipment
- Patch panel

### Features / Options – PRO RANGE 1/4" Phone Plug T-Series.

- Mono or Stereo (TRS)
- Stylised shell design with Ergonomic grip
- Nickel or Gold contact plating
- Keyed Shell
- Optional heavy duty metal backshell / boot
- Great solderability
- Increased solder area on ground contact
- "Jaws" Cable Clamp
- Precision machined contacts
- Coloured Grommet
- JUMBO Series Plugs

### Features / Options – MUSICIAN RANGE 1/4" Phone Plug

- Mono or Stereo (TRS)
- Compact Shell
- Straight or Right angle
- Stylish shell design
- Flexible grommet cable protection
- Nickel or Gold contact plating
- Satin Nickel or Black finish
- Diecast shell
- Coloured Grommet

### Features / Options – OEM RANGE 1/4" Phone Jack

- Mono or Stereo (TRS)
- Stackable (Piggy back) mounting
- Vertical or Horizontal PCB mount
- Mono and Stereo switched contacts
- Solder contacts
- Combo contacts
- Metal nut
- Plastic nut

### Features / Options – RCA Plug

- Red, Black, White, Yellow, Blue or Green shell colours
- Stylish shell design
- Flexible grommet cable protection
- Gold Plated Contacts

### Jaws Cable Clamp Options for T-Series



Standard Jaws cable clamp (Black), Cable O.D 3mm to 6mm (0.118" to 0.236")



Large Jaws cable clamp (Purple), Cable O.D 6mm to 7.5mm (0.236" to 0.295")

### Ordering Codes

We have listed the more common ordering codes in each section. Please contact us if you need any further assistance.

### Applicable Patents

US Patent No. 5,439,388

### Simple steps to guide you in using this catalogue

- 1) Identify the product group listed in Contents on Page 1 and go directly to that page number.
- 2) Each product group cover page then details information and options available.
- 3) Refer to the product detail pages and identify the product you require pictorially.
- 4) Read the product description column for the products standard features.
- 5) Use variations column to determine your choice.
- 6) Identify part number.
- 7) In the event the particular option you require is not listed please refer to the part number breakdown page at the end of each section.
- 8) Please contact us directly if you have any further problems.

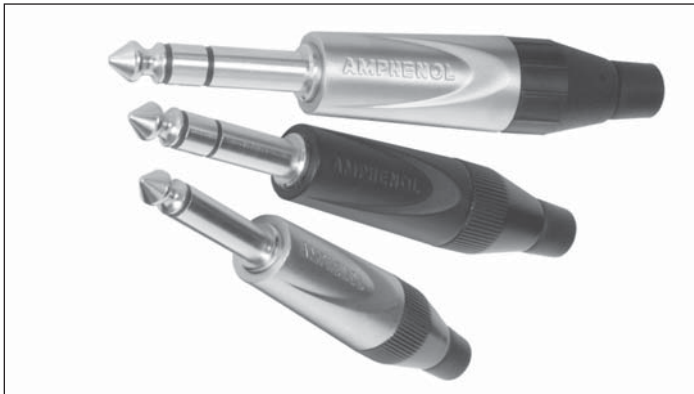





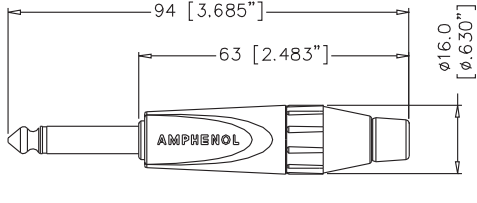

**Features:**

- Mono or Stereo (TRS).
- Stylised shell design with Ergonomic grip.
- Robust diecast shell in Satin nickel or Black finish.
- Nickel or Gold contact plating.
- Keyed shell.
- Optional heavy duty metal backshell / boot.
- Great solderability.
- Increased solder area on ground contact.
- "Jaws" Cable Clamp.
- Precision machined contacts.
- Quick and easy assembly.

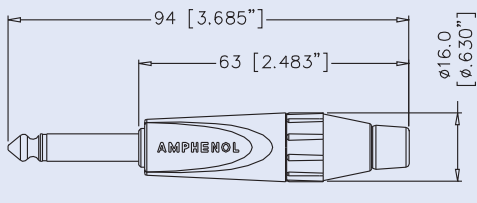

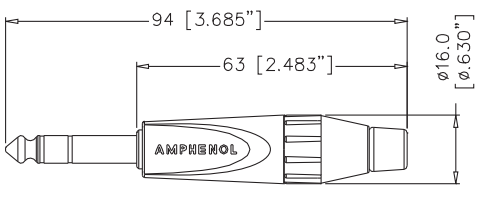

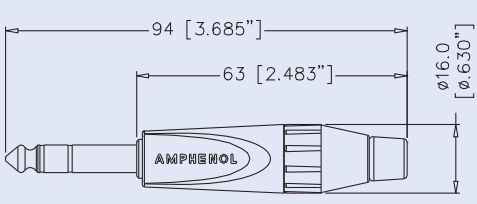
**Options:** Gold Contacts, Large or Small Jaws Cable Clamp, Black Shell, Metal Backshell / Boot, Bulk Pack. Coloured grommets (ordered separately)

**Part Number Breakdown:** Page 92    **Specifications:** Page 93

PRODUCT - FIGURE	DRAWING	DESCRIPTION	VARIATIONS	PART NUMBER
		1/4" (6.35mm $\varnothing$ ) Mono Phone plug, Jaws cable clamp, Thermoplastic backshell, Satin finish.	Standard	TM2P
			Gold Plated Contacts	TM2P-AU
			Large Cable Clamp	TM2PJ
			Bulk Pack	TM2P BULK
		1/4" (6.35mm $\varnothing$ ) Mono Phone plug, Jaws cable clamp, Thermoplastic backshell, Black finish.	Standard	TM2PB
			Gold Plated Contacts	TM2PB-AU
			Large Cable Clamp	TM2PBJ
			Bulk Pack	TM2PB BULK
		1/4" (6.35mm $\varnothing$ ) Stereo Phone plug, Jaws cable clamp, Thermoplastic backshell, Satin finish.	Standard	TS3P
			Gold Plated Contacts	TS3P-AU
			Large Cable Clamp	TS3PJ
			Bulk Pack	TS3P BULK
		1/4" (6.35mm $\varnothing$ ) Stereo Phone plug, Jaws cable clamp, Thermoplastic backshell, Black finish.	Standard	TS3PB
			Gold Plated Contacts	TS3PB-AU
			Large Cable Clamp	TS3PBJ
			Bulk Pack	TS3PB BULK





PRODUCT - FIGURE	DRAWING	DESCRIPTION	VARIATIONS	PART NUMBER
		1/4" (6.35mmø) Mono Phone plug, Jaws cable clamp, Metal backshell, Satin finish.	Standard	TM2PN
			Gold Plated Contacts	TM2PN-AU
			Large Cable Clamp	TM2PNJ
			Bulk Pack	TM2PN BULK
		1/4" (6.35mmø) Mono Phone plug, Jaws cable clamp, Metal backshell, Black finish.	Standard	TM2PBM
			Gold Plated Contacts	TM2PBM-AU
			Large Cable Clamp	TM2PBMJ
			Bulk Pack	TM2PBM BULK
		1/4" (6.35mmø) Stereo Phone plug, Jaws cable clamp, Metal backshell, Satin finish.	Standard	TS3PN
			Gold Plated Contacts	TS3PN-AU
			Large Cable Clamp	TS3PNJ
			Bulk Pack	TS3PN BULK
		1/4" (6.35mmø) Stereo Phone plug, Jaws cable clamp, Metal backshell, Satin finish.	Standard	TS3PBM
			Gold Plated Contacts	TS3PBM-AU
			Large Cable Clamp	TS3PBMJ
			Bulk Pack	TS3PBM BULK
		1/4" (6.35mmø) Stereo Phone plug, Jaws cable clamp, Metal backshell, Black finish.	Mono (Std. Clamp)	TM2PM
			Mono (Large Clamp)	TM2PMJ
			Stereo (Std. Clamp)	TS3PM
			Stereo (Large Clamp)	TS3PMJ BULK





**Features:**

- JUMBO Cable clamping capacity
- Suits Cable OD 7.5mm (0.295") to 10.5mm (0.413")
- Mono or Stereo (TRS).
- Stylised shell design with Ergonomic grip.
- Robust diecast shell in Satin nickel or Black finish.
- Nickel or Gold contact plating.
- Keyed shell.
- Great solderability.
- Increased solder area on ground contact.
- Precision machined contacts.
- Quick and easy assembly.

**Options:** Gold Contacts, Bulk Pack.

**Specifications:** Page 93

PRODUCT - FIGURE	DRAWING	DESCRIPTION	VARIATIONS	PART NUMBER
		1/4" (6.35mm $\varnothing$ ) JUMBO Mono Phone plug, Thermoplastic backshell, Satin finish.	Standard Gold Plated Contacts Bulk Pack	JM2P JM2P-AU JM2P BULK
		1/4" (6.35mm $\varnothing$ ) JUMBO Mono Phone plug, Thermoplastic backshell, Black finish.	Standard Gold Plated Contacts Bulk Pack	JM2PB JM2PB-AU JM2PB BULK
		1/4" (6.35mm $\varnothing$ ) JUMBO Stereo Phone plug, Thermoplastic backshell, Satin finish.	Standard Gold Plated Contacts Bulk Pack	JS3P JS3P-AU JS3P BULK
		1/4" (6.35mm $\varnothing$ ) JUMBO Stereo Phone plug, Thermoplastic backshell, Black finish.	Standard Gold Plated Contacts Bulk Pack	JS3PB JS3PB-AU JS3P BULK

NOTE: Contact factory for availability of metal backshells.



## PART NUMBER BREAKDOWN

### T-SERIES (PRO RANGE)

E. G. **TS3PBMJ-AU BULK**  
**T** (Series Prefix), **S3**(Stereo), **Plug Black**, **Metal Nut (Black)**, **J** (Large Jaws),  
**- AU** (Gold Plated Contacts), **Bulk** Packaged.

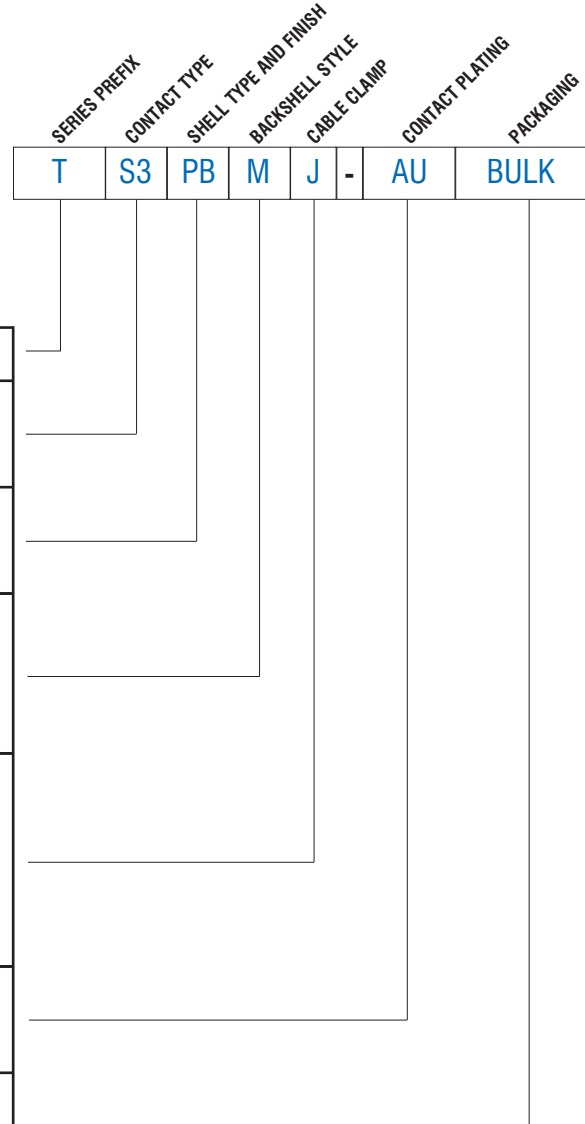

<b>SERIES PREFIX</b>	T	=	Series Prefix
<b>CONTACT TYPE</b>	M2	=	2 Pole (mono)
	S3	=	3 Pole, tip/ring/sleeve (stereo)
<b>SHELL TYPE AND FINISH</b>	P	=	Plug Satin Nickel
	PB	=	Plug Matt Black
<b>BACKSHELL TYPE</b>	Blank	=	Plastic Nut
	M	=	Metal Nut - Black
	N	=	Metal Nut - Satin Nickel
<b>CABLE CLAMP</b>	Blank	=	Standard Jaws 3mm to 6mm Cable O.D. (0.118"Ø to 0.236"Ø)
	J	=	Large Jaws 6mm to 7.5mm Cable O.D.(0.236"Ø to 0.295"Ø)
<b>CONTACT PLATING</b>	Blank	=	Nickel Plated Contacts (Standard)
	AU	=	Gold Plated Contacts
<b>PACKAGING</b>	Blank	=	Individual Bags
	BULK	=	Bulk Packed

### ISO VIEW OF TM2P

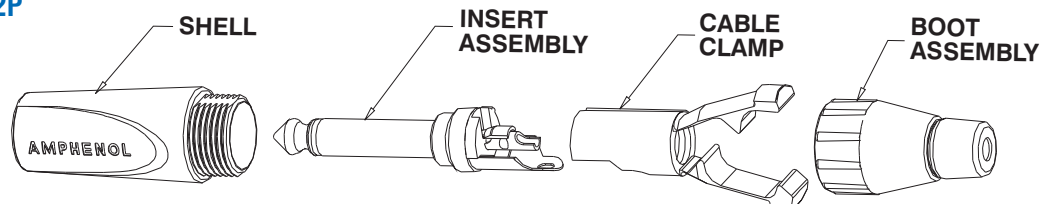

# Amphenol

## 1/4" PHONE PLUG TECHNICAL DATA

		VALUE
<b>GENERAL CHARACTERISTICS</b>	Number of Contacts	2 Pole (Mono) 3 Pole Tip Ring Sleeve (Stereo)
	Termination	Solder
	Max. Wire Gauge - Stranded Wire	2 Pole (Mono): AWG 16 - 1.5mm <sup>2</sup> 3 Pole (Stereo): AWG 18 - 1mm <sup>2</sup>
	Flammability rating of insulating plastics	UL94V-0
	Solderability, complies with	IEC 68-2-20
	Environmental	Complies with RoHS Directive 2002/95/EC
<b>ELECTRICAL CHARACTERISTICS</b>	Current Carrying Capacity	10A (Depends on Mating Connector and Cable)
	Typical Contact Resistance	Depends on Mating Connector
	Insulation resistance (initial)	>2GΩ
	After Damp Heat Test	≥1GΩ
	Dielectric Withstand Voltage	2 Pole : 1.5 kV dc 3 Pole : 1 kV dc
<b>CLIMATIC CHARACTERISTICS</b>	Protection Class	IP40
	Operating Temperature	-25°C to +75°C (-13°F to + 167°F)
<b>MECHANICAL CHARACTERISTICS</b>	Insertion and Withdrawal Force	≥10N - ≤30N
	Weight <sup>1)</sup> - Thermoplastic Backshell	28g (0.061lb)
	Weight <sup>1)</sup> - Metal Backshell	35g (0.077lb)
	Typical Cable Retention Force	22kg to 44kg (50lb to 100lb) - Dependent on cable material and diameter.
	Cable O.D. - Standard Jaw Cable O.D. - Large Jaw Cable O.D. - Jumbo	3mm to 6mm (0.118" to 0.236") 6mm to 7.5mm (0.236" to 0.295") 7.5mm to 10.5mm (0.295" to 0.413")
<b>MATERIALS</b>	Connector Shell Material	Diecast Zinc Alloy EZDA No.3
	Shell Finish	Satin Nickel or Black Polyester
	Insulators	UL94 V-0 PBT Resin or Modified PPE Resin - Black
	Boot / Backshell	UL94 V-0 PBT Resin or Modified PPE Resin - Black or Metal CuZn <sup>39</sup> Pb <sup>3</sup>
	Cable Clamp	UL94 V-0 PBT Modified PPO Resin - Black
	Cable Bushing	Thermoplastic Polyurethane
	Contacts / Plating	Brass /Ni or Au over 2μm Ni

Rev 2 - 09/2005

<sup>1)</sup> Approximate weight only, does not include packaging. Please contact us for exact weight for shipping purposes.









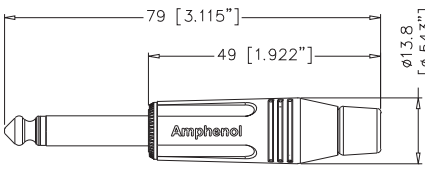

**Features:**

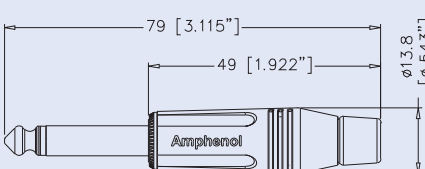

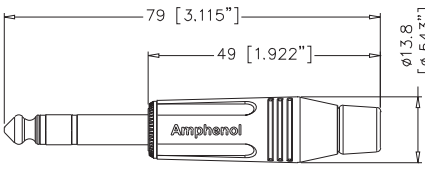

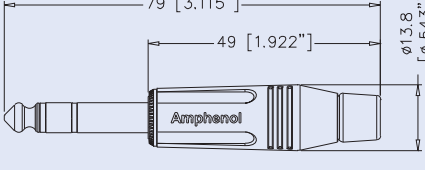
- Mono or Stereo (TRS).
- Stylish shell design.
- Robust diecast shell in Satin nickel or Black finish.
- Nickel or Gold contact plating.
- Flexible grommet cable protection.
- Improved solderability.
- Precision machined contacts.
- Standard or Bulk packaging.

**Options:** Black Shell, Gold contacts. Coloured grommets (ordered separately)

**Specifications:** Page 101

PRODUCT - FIGURE	DRAWING	DESCRIPTION	VARIATIONS	PART NUMBER
		1/4" (6.35mmø) Mono Phone plug, Diecast Shell, Satin finish, Flexible grommet.	Standard	ACPM-GN
			Gold Plated Contacts	ACPM-GN-AU
			Bulk Pack	ACPM-GN BULK
		1/4" (6.35mmø) Mono Phone plug, Diecast Shell, Black finish, Flexible grommet.	Standard	ACPM-GB
			Gold Plated Contacts	ACPM-GB-AU
			Bulk Pack	ACPM-GB BULK
		1/4" (6.35mmø) Stereo Phone plug, Diecast Shell, Satin finish, Flexible grommet.	Standard	ACPS-GN
			Gold Plated Contacts	ACPS-GN-AU
			Bulk Pack	ACPS-GN BULK
		1/4" (6.35mmø) Stereo Phone plug, Diecast Shell, Black finish, Flexible grommet.	Standard	ACPS-GB
			Gold Plated Contacts	ACPS-GB-AU
			Bulk Pack	ACPS-GB BULK



PRODUCT - FIGURE	DRAWING	DESCRIPTION	TYPE	PART NUMBER
		<p>1/4" (6.35mmø) Mono Phone plug, Right angle, Diecast Shell, Satin finish, Flexible grommet.</p>	Standard	ACPM-RN
			Gold contacts	ACPM-RN-AU
			Bulk Pack	ACPM-RN BULK
		<p>1/4" (6.35mmø) Mono Phone plug, Right angle, Diecast Shell, Black finish, Flexible grommet.</p>	Standard	ACPM-RB
			Gold contacts	ACPM-RB-AU
			Bulk Pack	ACPM-RB BULK
		<p>1/4" (6.35mmø) Stereo Phone plug, Right angle, Diecast Shell, Satin finish, Flexible grommet.</p>	Standard	ACPS-RN
			Gold contacts	ACPS-RN-AU
			Bulk Pack	ACPS-RN BULK
		<p>1/4" (6.35mmø) Stereo Phone plug, Right angle, Diecast Shell, Black finish, Flexible grommet.</p>	Standard	ACPS-RB
			Gold contacts	ACPS-RB-AU
			Bulk Pack	ACPS-RB BULK





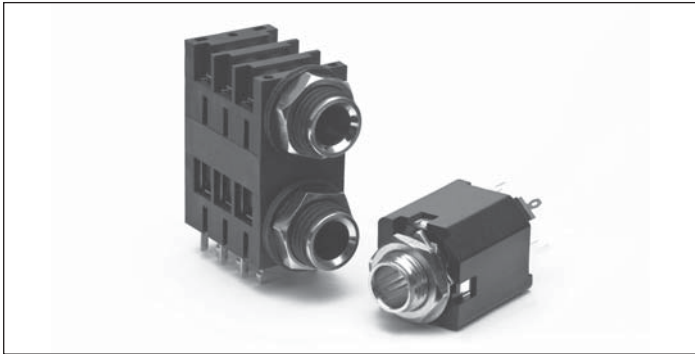

**Features:**

- 3.5mm and 6.35mm (1/4") options
- Mono or Stereo (TRS)
- Single or Dual mounting
- Vertical or Horizontal PCB mount
- Mono and Stereo with switching contacts
- Solder or Combo contacts
- Various mounting option







**Specifications:** Pages 101

PRODUCT - FIGURE	DRAWING	Dimensions in mm (inches)	DESCRIPTION	VARIATIONS	PART NUMBER
			3.5mm Jack, Horizontal PCB, Plastic housing, Metal entry bore	Mono Stereo	ACJM-NH35 ACJS-NH35
			1/4" (6.35mmø) Phone Jack, Horizontal Snap-fit PCB, Plastic housing, Metal nut and entry bore	Mono Stereo	ACJM - MHDR ACJS - MHDR
			3.5mm / 1/4" (6.35mmø) Dual Phone Jack, (Piggyback), Horizontal PCB, Plastic housing, Metal nut and entry bore	Mono Stereo	ACJM - MHD985 ACJS - MHD985
			1/4" (6.35mmø) Dual Phone Jack (Piggyback) Horizontal Snap-fit PCB, Plastic housing, Metal nut and entry bore	Mono Stereo	ACJM - MHD* ACJS - MHD*
			1/4" (6.35mmø) Dual Phone Jack (Piggyback) Shielding plate, Horizontal Snap-fit PCB, Plastic housing, Metal nut and entry bore	Mono Stereo	ACJM-MHDE* ACJS-MHDE*
			1/4" (6.35mmø) Dual Phone Jack (Compact Piggyback), Horizontal Snap-fit PCB, Plastic housing, Metal nut and entry bore	Mono Stereo	ACJM-MHDC ACJS-MHDC

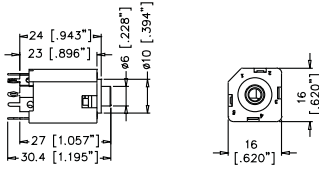

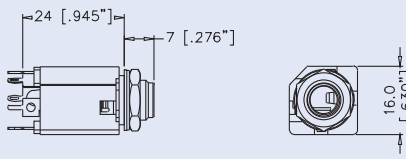
PRODUCT - FIGURE	DRAWING	Dimensions in mm (inches)	DESCRIPTION	VARIATIONS	PART NUMBER
N / A			1/4" (6.35mmØ) Offset Jack, Horizontal PCB mount, Plastic housing, thread and entry bore	<ul style="list-style-type: none"> <li>Mono - Plastic Nut</li> <li>Mono - Metal Nut</li> <li>Stereo - Plastic Nut</li> <li>Stereo - Metal Nut</li> </ul>	<ul style="list-style-type: none"> <li>ACJM-PHOP</li> <li>ACJM-MHOP</li> <li>ACJS-PHOP</li> <li>ACJS-MHOP</li> </ul>
			1/4" (6.35mmØ) Offset Jack, Horizontal PCB mount, Plastic housing, Metal thread and entry bore with Chassis ground connection	<ul style="list-style-type: none"> <li>Mono - Metal Nut</li> <li>Stereo - Metal Nut</li> </ul>	<ul style="list-style-type: none"> <li>ACJM-MHOM</li> <li>ACJS-MHOM</li> </ul>
			1/4" (6.35mmØ) Jack, Horizontal PCB mount, Plastic housing with metal insert	<ul style="list-style-type: none"> <li>Mono - Plastic Nut</li> <li>Mono - Metal Nut</li> </ul>	<ul style="list-style-type: none"> <li>ACJM - PH</li> <li>ACJM - MH</li> </ul>
			1/4" (6.35mmØ) Jack, Horizontal PCB mount, Plastic housing with metal insert	<ul style="list-style-type: none"> <li>Stereo - Plastic Nut</li> <li>Stereo - Metal Nut</li> </ul>	<ul style="list-style-type: none"> <li>ACJS - PH</li> <li>ACJS - MH</li> </ul>
			1/4" (6.35mmØ) Jack, Horizontal Snap-fit PCB mount, Plastic housing with metal insert	<ul style="list-style-type: none"> <li>Mono - Plastic Nut</li> <li>Mono - Metal Nut</li> <li>Stereo - Plastic Nut</li> <li>Stereo - Metal Nut</li> </ul>	<ul style="list-style-type: none"> <li>ACJM-PHR</li> <li>ACJM-MHR</li> <li>ACJS-PHR</li> <li>ACJS-MHR</li> </ul>
			1/4" (6.35mmØ) Jack, Combination Horizontal PCB and Solder lug, Plastic housing with metal insert	<ul style="list-style-type: none"> <li>Mono - Plastic Nut</li> <li>Mono - Metal Nut</li> <li>Stereo - Plastic Nut</li> <li>Stereo - Metal Nut</li> </ul>	<ul style="list-style-type: none"> <li>ACJM - PC</li> <li>ACJM - MC</li> <li>ACJS - PC</li> <li>ACJS - MC</li> </ul>
			1/4" (6.35mmØ) Jack, Solder Lug, Plastic housing with metal insert	<ul style="list-style-type: none"> <li>Mono - Plastic Nut</li> <li>Mono - Metal Nut</li> <li>Stereo - Plastic Nut</li> <li>Stereo - Metal Nut</li> </ul>	<ul style="list-style-type: none"> <li>ACJM-PHS</li> <li>ACJM-MHS</li> <li>ACJS-PHS</li> <li>ACJS-MHS</li> </ul>
			1/4" (6.35mmØ) Jack, Horizontal PCB mount, Plastic housing and Bezel with threaded Metal nut.	<ul style="list-style-type: none"> <li>Mono</li> <li>Stereo</li> </ul>	<ul style="list-style-type: none"> <li>ACJM-IH</li> <li>ACJS-IH</li> </ul>

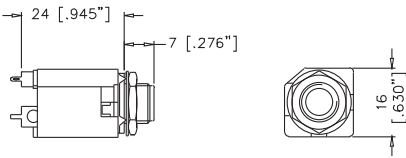

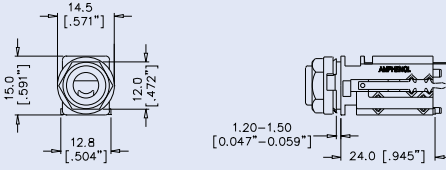
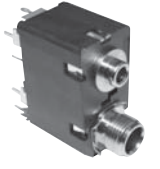
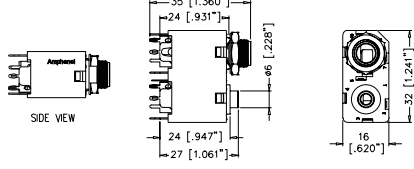
PRODUCT - FIGURE	DRAWING	DESCRIPTION	TYPE	PART NUMBER
		3.5mm Jack, Vertical PCB mount, Needle eye contacts, Plastic housing, Metal entry bore	Refer circuit schematic chart page 99	ACJM-NV35-2 ACJM-NV35-2S ACJS-NV35-3 ACJS-NV35-3S ACJS-NV35-5
		1/4" (6.35mmØ) Jack, Vertical PCB mount, Needle eye contacts, Star washer, Metal nut and insert	Refer circuit schematic chart page 99	ACJM-MN-2 ACJS-MN-3 ACJM-MN-2S ACJS-MN-3S ACJS-MN-5
		1/4" (6.35mmØ) Jack, Vertical PCB mount, Metal nut and insert	Mono Stereo	ACJM-MV ACJS-MV
		1/4" (6.35mmØ) Jack, Vertical PCB mount, Plastic housing, nut and entry bore	Refer circuit schematic chart page 99	ACJM-PVB-2 ACJM-PVB-2S ACJS-PVB-3 ACJS-PVB-3S ACJS-PVB-5
		3.5mm / 1/4" (6.35mmØ) Dual Phone Jack, Vertical PCB mount, Needle eye contacts, Plastic housing, Metal nut and entry bore	Refer circuit schematic chart page 99	ACJM-MVD985-2 ACJM-MVD985-2S ACJS-MVD985-3 ACJS-MVD985-3S ACJS-MVD985-5



## PANEL CUTOUTS -FRONT VIEW

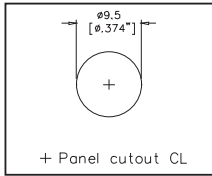

ACJM-MV  
ACJS-MV  
ACJM-MN-2  
ACJS-MN-3  
ACJM-MN-2S  
ACJS-MN-3S  
ACJM-MN-5  
ACJS-MN-5

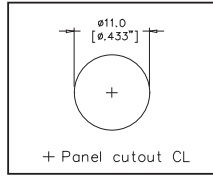

ACJM/S-PH  
ACJM/S-MH  
ACJM/S-PC  
ACJM/S-MC  
ACJM/S-PHR  
ACJM/S-MHR  
ACJM/S-PHS  
ACJM/S-MHS

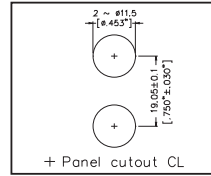

ACJM-MHD  
ACJS-MHD  
ACJM-MHDE  
ACJS-MHDE

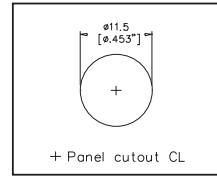

ACJM-MHDR  
ACJS-MHDR

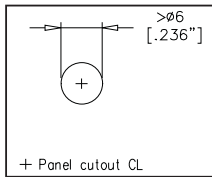

ACJM-NH35  
ACJS-NH35

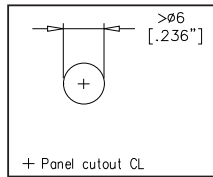

ACJM-NV35-2  
ACJM-NV35-2S  
ACJS-NV-35-3  
ACJS-NV-35-5

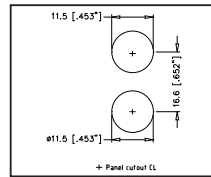

ACJS-MHDC  
ACJM-MHDC

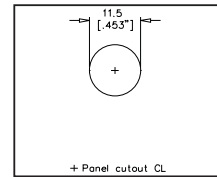

ACJS-IH  
ACJM-IH

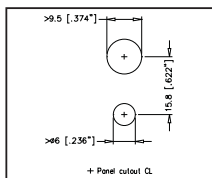

ACJS-MHD985  
ACJM-MHD985

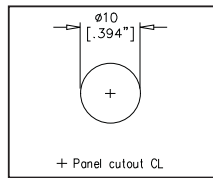

ACJS-MHOM  
ACJM-MHOM

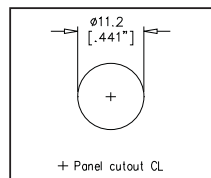

ACJS-MHOP  
ACJS-PHOP  
ACJM-MHOP  
ACJM-PHOP

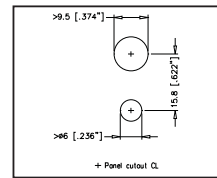

ACJS-MVD985  
ACJM-MVD985

## SCHEMATIC CHART

PART NO.	ACJM-MN-2 ACJM-NV35-2 ACJM-PVB-2	ACJM-MN-2S ACJM-NV35-2S ACJM-PVB-2S	ACJS-MN-3 ACJS-NV35-3 ACJS-PVB-3	ACJS-MN-3S ACJS-NV35-3S ACJS-PVB-3S	ACJS-MN-5 ACJS-NV35-5 ACJS-PVB-5
<b>GENERAL SCHEMATIC</b>					

PART NO.	ACJM-MVD985-2	ACJM-MVD985-2S	ACJS-MVD985-3	ACJS-MVD985-3S	ACJS-MVD985-5
<b>SCHEMATIC</b>					



## PCB FOOTPRINT - CONNECTOR SIDE OF PCB

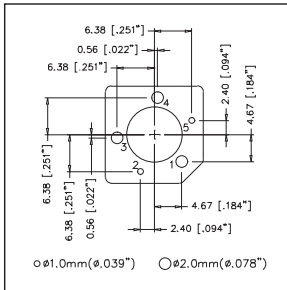

**ACJM-MV**  
**ACJM-MN-2**  
**ACJM-MN-3**  
**ACJM-MN-3S**  
**ACJM-MN-5**  
**ACJM-NV-35-2**  
**ACJM-NV-35-3**  
**ACJM-NV35-3S**  
**ACJM-NV35-5**

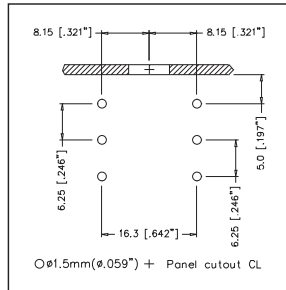

**ACJM-PH**  
**ACJM-MH**  
**ACJS-PH**  
**ACJS-MH**  
**ACJM-MC**  
**ACJS-MC**  
**ACJM-PC**  
**ACJS-PC**

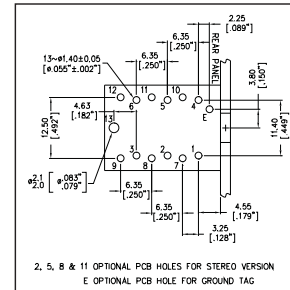

**ACJM-MHD**  
**ACJS-MHD**  
**ACJM-MHDE**  
**ACJS-MHDE**  
**ACJM-MHDC**  
**ACJS-MHDC**

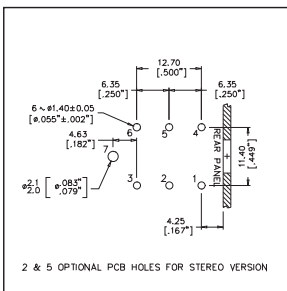

**ACJM-MHDR**  
**ACJS-MHDR**  
**ACJM-PHR**  
**ACJS-PHR**  
**ACJM-MHR**  
**ACJS-MHR**

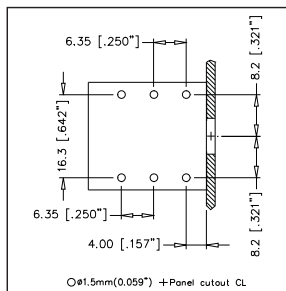

**ACJS-IH**  
**ACJM-IH**

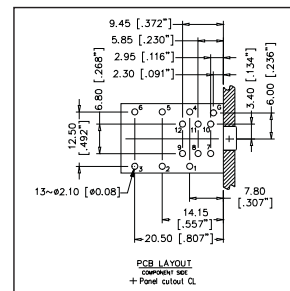

**ACJS-MHD985**  
**ACJM-MHD985**

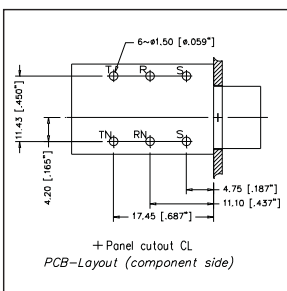

**ACJS-MHOM**  
**ACJM-MHOM**

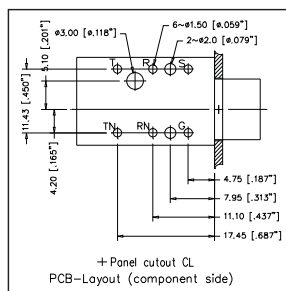

**ACJS-MHOP**  
**ACJS-PHOP**  
**ACJM-PHOP**

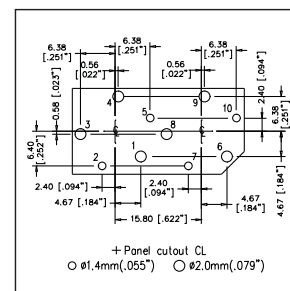

**ACJS-MVD985**  
**ACJM-MVD985**

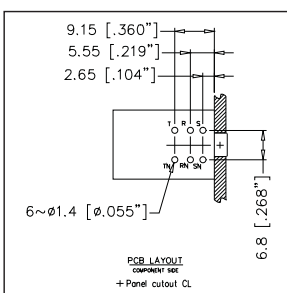

**ACJS-NH35**  
**ACJM-NH35**

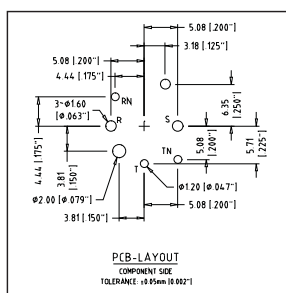

**ACJM-PVB-2**  
**ACJM-PVB-2S**  
**ACJS-PVB-3**  
**ACJS-PVB-3S**  
**ACJM-PVB-5**

## PLUG AND JACKS TECHNICAL DATA

		VALUE
<b>GENERAL CHARACTERISTICS</b>	Number of Contacts	2 Pole (Mono) 3 Pole Tip Ring Sleeve (Stereo)
	Termination	Solder, PCB or Combo
	Max. Wire Gauge - Stranded Wire	2 Pole (Mono): AWG 16 - 1.5mm <sup>2</sup> 3 Pole (Stereo): AWG 18 - 1mm <sup>2</sup>
	Flammability rating of insulating plastics	UL94V-0
	Solderability, complies with	IEC 68-2-20
	Environmental	Complies with RoHS Directive 2002/95/EC
<b>ELECTRICAL CHARACTERISTICS</b>	Current Carrying Capacity	10A (Depends on Mating Connector and Cable)
	Typical Contact Resistance	Depends on Mating Connector
	Insulation resistance (initial)	>2GΩ
	After Damp Heat Test	≥1GΩ
	Dielectric Withstand Voltage	2 Pole : 1.5 kV dc 3 Pole : 1 kV dc
<b>CLIMATIC CHARACTERISTICS</b>	Protection Class	IP40
	Operating Temperature	-25°C to +75°C (-13°F to + 167°F)
<b>MECHANICAL CHARACTERISTICS</b>	Insertion and Withdrawal Force	≥10N - ≤30N
	Cable O.D. (Plugs)	6mm (0.236")
<b>MATERIALS</b>	Connector Shell Material (Plugs)	Diecast Zinc Alloy EZDA No.3
	Connector Shell Material (Jacks)	UL94 V-0 PBT Modified PPO Resin - Black
	Connector Shell Finish	Satin Nickel, Nickel or Black Polyester
	Insulators	UL94 V-0 PBT Resin or Modified PPE Resin and fibreglass laminate
	Cable Bushing	Thermoplastic Polyurethane
	Contacts / Plating (Plugs)	Brass / Ni over Cu (Copper)
Contacts / Plating (Jacks)	Brass / Sn (Tin) over Cu (Copper)	

Rev 1 - 09/2005

<sup>1)</sup> Approximate weight only, does not include packaging. Please contact us for exact weight for shipping purposes.









**Features:**

- Stylish design
- Flexible grommet cable protection
- Robust diecast shell
- Gold plated contacts
- Colour coded
- Good solderability
- Quick and easy assembly
- Panel mount utilises standard 'D' type housing

**Options:** Satin Nickel shell finish with coloured grommet, Bulk Pack.

PRODUCT - FIGURE	DRAWING	Dimensions in mm (inches)	DESCRIPTION	COLOUR	PART NUMBER
			RCA Plug, Diecast Shell, Gold plated contacts, Coloured finish, Flexible coloured grommet.	Red	ACPR-RED
				Black	ACPR-BLK
				Yellow	ACPR-YEL
				White	ACPR-WHT
				Blue	ACPR-BLU
			RCA Jack, Diecast Shell, Gold plated contacts, Coloured finish, Flexible coloured grommet.	Red	ACJR-RED
				Black	ACJR-BLK
				Yellow	ACJR-YEL
				White	ACJR-WHT
				Blue	ACJR-BLU
			RCA Jack, Diecast Shell, Gold plated contacts, Nickel finish shell, coloured insulator.	Red	ACJD-RED
				Black	ACJD-BLK
				Yellow	ACJD-YEL
				White	ACJD-WHT
				Blue	ACJD-BLU
				Green	ACJD-GRN

NOTE: RCA Series comply with RoHS Directive 2002/95/EC



**Features:**

- Miniature version of the standard XLR series.
- Diecast or Precision machined metal housings.
- Metal cable clamp supports cables from 2mm to 3.5mm (0.078" to 0.137")
- Precision machined pin contacts.
- Stamped socket contacts
- Solder cup or Printed Circuit board contacts
- Available in 3, 4, 5 or 6 contacts
- Positive latchlock
- Flexible cable grommet

PRODUCT - FIGURE	DRAWING Dimensions in mm (inches)	DESCRIPTION	VARIATIONS	PART NUMBER
		Male cable connector, Machined contacts, Nickel Finish	3 pole 4 pole 5 pole 6 pole	AG3M AG4M AG5M AG6M
		Female cable connector, Stamped contacts, Nickel Finish	3 pole 4 pole 5 pole 6 pole	AG3F AG4F AG5F AG6F
		Male chassis connector, Machined contacts, Nickel Finish	3 pole 4 pole 5 pole 6 pole	AG3MCC AG4MCC AG5MCC AG6MCC
		Female chassis connector, Stamped contacts, Nickel Finish	3 pole 4 pole 5 pole 6 pole	AG3FCRV AG4FCRV AG5FCRV AG6FCRV





## MULTIPIN CONNECTORS

Amphenol has an extensive range of circular and rectangular multi-pin connectors ideally suited to the entertainment industry. Featuring rugged housings and precision made contacts these connectors have proven themselves in the most demanding of applications. The extensive arrangement of different connector sizes and contact numbers ensure we can offer a solution to your multi-pin wiring applications.

### Applications

- Audio Cables and Snakes
- Lighting control
- Concert Touring Systems
- Outside Broadcast Systems

### Features / Options - MP-41 Series

- 13 to 150 pins
- Gold plated "combo" contacts
- Synthetic inserts
- Environmental resistant
- Positive Bayonet locking
- PG cable gland
- 2000 mating cycles
- Bayonet wear pins
- Extended coupling ring

### Features / Options - MP-62 Series

- 39 or 61 pins
- Gold plated solder contacts
- Neoprene inserts
- Environmental resistant
- Positive Bayonet locking
- PG cable gland or NPT thread

### Ordering Codes

We have listed the more common ordering codes in each section. For further options please contact us.

### Simple steps to guide you in using this catalogue

- 1) Identify the product group listed in Contents on Page 1 and go directly to that page number.
- 2) Each product group cover page then details information and options available.
- 3) Refer to the product detail pages and identify the product you require pictorially.
- 4) Read the product description column for the products standard features.
- 5) Use pins column to determine number of contacts.
- 6) Identify part number.
- 7) In the event the particular option you require is not listed please refer to the part number breakdown page at the end of each section.
- 8) Please contact us directly if you have any further problems.



Amphenol's MP-41 series of multipin connectors utilise the same design principals of the rugged Mil-C-5015 military connectors. They can withstand high shock and vibration environments and are ideal for tough on-road applications. Featuring a quick mating bayonet coupling with an audible full mating feature ensures a positive connection every time. Available from 13 to 150 pins with gold plated "combo"\* contacts supplied with each connector as standard.

**Features:**



- 13 to 150 pins ( 4 to 48 channel)
- Gold plated "combo"\* contacts
- Synthetic insert
- Protective dust caps
- Industry standard compatible
- 2000 mating cycles
- Black finish
- Positive bayonet locking
- PG cable glands
- IP67 rated

**Options:** NPT threaded backshells.

**Crimp Tooling:** Page 108

**Specifications:** Page 110

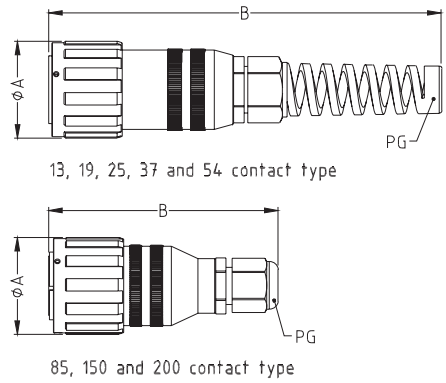

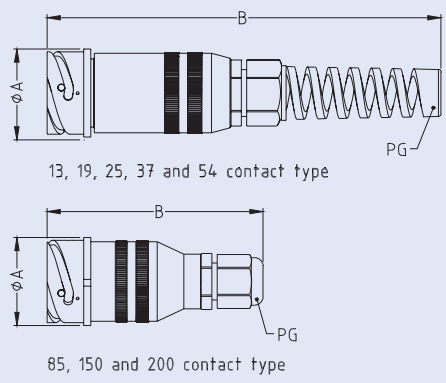



**Part Number Breakdown:** Page 109

PRODUCT - FIGURE	Dimensions in mm (inches) <b>DRAWING</b>	Dimensions in mm (inches)			PINS	PART NUMBER	PART NUMBER With Dustcap
		A	B	PG			
 <p>Straight cable plug with socket contacts, Black finish, supplied complete with gold plated solder / crimp "combo"* contacts.</p> <p>13, 19, 25, 37 and 54 contact type</p> <p>85, 150 and 200 contact type</p>		40.5 (1.60)	160 (6.30)	11	13	MP-4106-13S	MP-4106-13S-C
		44 (1.73)	171 (6.73)	13.5	19	MP-4106-19S	MP-4106-19S-C
		46.6 (1.83)	193 (7.60)	16	25	MP-4106-25S	MP-4106-25S-C
		54.3 (2.14)	210 (8.26)	21	37	MP-4106-37S	MP-4106-37S-C
		60.1 (2.36)	210 (8.26)	21	54	MP-4106-54S	MP-4106-54S-C
		73.3 (2.88)	137 (5.40)	29	85	MP-4106-85S	MP-4106-85S-C
		73.3 (2.88)	145 (5.70)	36	150	MP-4106-150S	MP-4106-150S-C
 <p>Cable connecting receptacle with pin contacts, black finish, supplied complete with gold plated solder / crimp "combo"* contacts.</p> <p>13, 19, 25, 37 and 54 contact type</p> <p>85, 150 and 200 contact type</p>		37.8 (1.49)	160 (6.30)	11	13	MP-4101-13P	MP-4101-13S-C
		41.1 (1.62)	171 (6.73)	13.5	19	MP-4101-19P	MP-4101-19S-C
		41.5 (1.63)	193 (7.60)	16	25	MP-4101-25P	MP-4101-25S-C
		51 (2.00)	210 (8.26)	21	37	MP-4101-37P	MP-4101-37S-C
		57.1 (2.25)	210 (8.26)	21	54	MP-4101-54P	MP-4101-54S-C
		70 (2.75)	137 (5.40)	29	85	MP-4101-85P	MP-4101-85S-C
		70 (2.75)	145 (5.70)	36	150	MP-4101-150P	MP-4101-150S-C

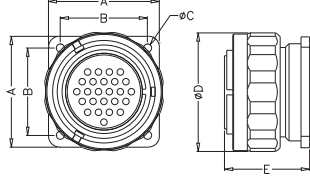

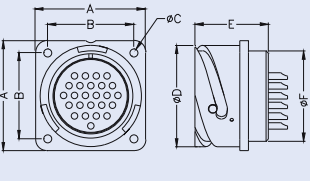
Note: NPT threaded backshells available on request. Please contact us.

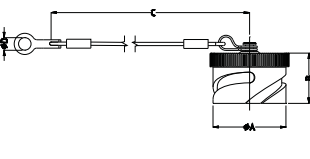
\*"Combo" contacts not available to suit 150 pin connectors, supplier with crimp type only

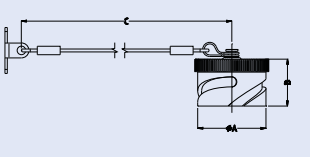

PRODUCT - FIGURE	Dimensions in mm (inches) DRAWING	Dimensions in mm (inches)						PINS	PART NUMBER	PART NUMBER With Dustcap
		A	B	C	D	E	F			
 <p>Panel plug with socket contacts, black finish, supplied complete with gold plated solder / crimp "combo"* contacts.</p> 	<p>Panel plug with socket contacts, black finish, supplied complete with gold plated solder / crimp "combo"* contacts.</p>	38 (1.49)	29.4 (1.15)	3.2 (0.13)	40.5 (1.60)	38.8 (1.53)	N/A	13	MP-4164-13S	MP-4164-13S-C
		41 (1.61)	31.8 (1.25)	3.2 (0.13)	44 (1.73)	38.8 (1.53)	N/A	19	MP-4164-19S	MP-4164-19S-C
		44.5 (1.75)	34.9 (1.37)	3.73 (0.14)	48.51 (1.91)	40.6 (1.60)	N/A	25	MP-4164-25S	MP-4164-25S-C
		50.8 (1.99)	39.7 (1.56)	3.73 (0.14)	54.3 (2.14)	42 (1.65)	N/A	37	MP-4164-37S	MP-4164-37S-C
		57 (2.24)	44.5 (1.75)	4.39 (0.17)	60.8 (2.40)	45 (1.77)	N/A	54	MP-4164-54S	MP-4164-54S-C
		69.8 (2.74)	55.5 (2.18)	4.39 (0.17)	73.3 (2.88)	45 (1.77)	N/A	85	MP-4164-85S	MP-4164-85S-C
		69.8 (2.74)	55.5 (2.18)	4.39 (0.17)	73.3 (2.88)	45 (1.77)	N/A	150	MP-4164-150S	MP-4164-150S-C
		69.8 (2.74)	55.5 (2.18)	4.39 (0.17)	73.3 (2.88)	45 (1.77)	N/A	150	MP-4164-150S	MP-4164-150S-C
 <p>Panel receptacle with pin contacts, black finish, supplied complete with gold plated solder / crimp "combo"* contacts.</p> 	<p>Panel receptacle with pin contacts, black finish, supplied complete with gold plated solder / crimp "combo"* contacts.</p>	38 (1.49)	29.4 (1.15)	3.23 (0.13)	34.2 (1.34)	34.5 (1.35)	29 (1.14)	13	MP-4102-13P	MP-4102-13P-C
		41 (1.61)	31.8 (1.25)	3.23 (0.13)	37.4 (1.47)	34.5 (1.35)	32.2 (1.26)	19	MP-4102-19P	MP-4102-19P-C
		44.5 (1.75)	34.9 (1.37)	3.73 (0.14)	40.9 (1.61)	35.7 (1.40)	35.3 (1.38)	25	MP-4102-25P	MP-4102-25P-C
		50.8 (1.99)	39.7 (1.56)	3.73 (0.14)	46.7 (1.83)	36.5 (1.44)	41.4 (1.62)	37	MP-4102-37P	MP-4102-37P-C
		57 (2.24)	44.5 (1.75)	4.30 (0.17)	53.4 (2.10)	38.5 (1.52)	47.8 (1.88)	54	MP-4102-54P	MP-4102-54P-C
		69.8 (2.74)	55.5 (2.18)	4.30 (0.17)	65.5 (2.57)	38.5 (1.52)	59 (2.32)	85	MP-4102-85P	MP-4102-85P-C
		69.8 (2.74)	55.5 (2.18)	4.30 (0.17)	65.5 (2.57)	38.5 (1.52)	59 (2.32)	150	MP-4102-150P	MP-4102-150P-C
		69.8 (2.74)	55.5 (2.18)	4.30 (0.17)	65.5 (2.57)	38.5 (1.52)	59 (2.32)	150	MP-4102-150P	MP-4102-150P-C
 <p>Plug protective dustcap to suit MP-4164 type.</p> 	<p>Plug protective dustcap to suit MP-4164 type.</p>	34.16 (1.35)	31.5 (1.24)	110 (4.33)	4.7 (0.18)	-	-	13	MP-25042-13S	-
		37.36 (1.47)	31.5 (1.24)	110 (4.33)	4.7 (0.18)	-	-	19	MP-25042-19S	-
		40.87 (1.61)	31.5 (1.24)	110 (4.33)	4.7 (0.18)	-	-	25	MP-25042-25S	-
		46.68 (1.84)	31.5 (1.24)	110 (4.33)	4.7 (0.18)	-	-	37	MP-25042-37S	-
		53.36 (2.10)	31.5 (1.24)	110 (4.33)	5.5 (0.22)	-	-	54	MP-25042-54S	-
		65.48 (2.58)	31.5 (1.24)	110 (4.33)	5.5 (0.22)	-	-	85	MP-25042-85S	-
		65.48 (2.58)	31.5 (1.24)	110 (4.33)	5.5 (0.22)	-	-	150	MP-25042-150S	-
		65.48 (2.58)	31.5 (1.24)	110 (4.33)	5.5 (0.22)	-	-	150	MP-25042-150S	-
 <p>Receptacle protective dustcap to suit MP-4106 types.</p> 	<p>Receptacle protective dustcap to suit MP-4106 types.</p>	38.8 (1.53)	20.7 (0.81)	255 (8.07)	-	-	-	13	MP-25042-13L	-
		41.6 (1.64)	20.7 (0.81)	255 (8.07)	-	-	-	19	MP-25042-19L	-
		45.3 (1.78)	20.7 (0.81)	255 (8.07)	-	-	-	25	MP-25042-25L	-
		52.15 (2.05)	20.7 (0.81)	255 (8.07)	-	-	-	37	MP-25042-37L	-
		58.6 (2.30)	20.7 (0.81)	255 (8.07)	-	-	-	54	MP-25042-54L	-
		70.7 (2.78)	20.7 (0.81)	255 (8.07)	-	-	-	85	MP-25042-85L	-
		70.7 (2.78)	20.7 (0.81)	255 (8.07)	-	-	-	150	MP-25042-150L	-
		70.7 (2.78)	20.7 (0.81)	255 (8.07)	-	-	-	150	MP-25042-150L	-

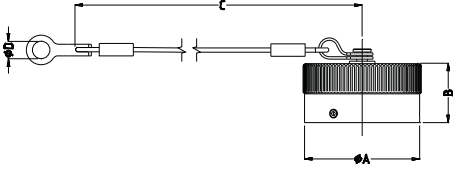
\*"Combo" contacts not available to suit 150 pin connectors, supplier with crimp type only

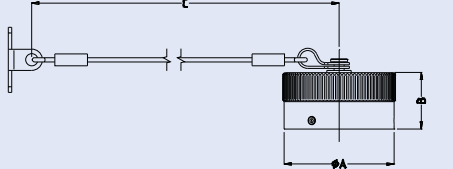
PRODUCT - FIGURE	Dimensions in mm (inches) DRAWING	Dimensions in mm (inches)						PINS	PART NUMBER
		A	B	C	D	E	F		
	<p>Plug protective dustcap to suit MP-4102 types.</p> 	34.16 (1.35)	31.5 (1.24)	110 (4.33)	4.7 (0.18)	-	-	13	MP-25043-13S
		37.36 (1.47)	31.5 (1.24)	110 (4.33)	4.7 (0.18)	-	-	19	MP-25043-19S
		40.87 (1.61)	31.5 (1.24)	110 (4.33)	4.7 (0.18)	-	-	25	MP-25043-25S
		46.68 (1.84)	31.5 (1.24)	110 (4.33)	4.7 (0.18)	-	-	37	MP-25043-37S
		53.36 (2.10)	31.5 (1.24)	110 (4.33)	5.5 (0.22)	-	-	54	MP-25043-54S
		65.48 (2.58)	31.5 (1.24)	110 (4.33)	5.5 (0.22)	-	-	85	MP-25043-85S
		65.48 (2.58)	31.5 (1.24)	110 (4.33)	5.5 (0.22)	-	-	150	MP-25043-150S
			<p>Receptacle protective dustcap to suit MP-4101 types.</p> 	38.8 (1.53)	20.7 (0.81)	255 (8.07)	-	-	-
41.6 (1.64)	20.7 (0.81)			255 (8.07)	-	-	-	19	MP-25043-19L
45.3 (1.78)	20.7 (0.81)			255 (8.07)	-	-	-	25	MP-25043-25L
52.15 (2.05)	20.7 (0.81)			255 (8.07)	-	-	-	37	MP-25043-37L
58.6 (2.30)	20.7 (0.81)			255 (8.07)	-	-	-	54	MP-25043-54L
70.7 (2.78)	20.7 (0.81)			255 (8.07)	-	-	-	85	MP-25043-85L
70.7 (2.78)	20.7 (0.81)			255 (8.07)	-	-	-	150	MP-25043-150L





PRODUCT - FIGURE	DRAWING	DESCRIPTION	NO. OF PINS	PART NUMBER
	NOT APPLICABLE	Crimp Tool	All	M22520/1-01
	NOT APPLICABLE	Positioner / Turret	All	TH29-1
	NOT APPLICABLE	Insertion tool	13-85	MP-INS-16
			150	MP-INS-18
	NOT APPLICABLE	Extraction tool	All	MP-EXT-16/18
	NOT APPLICABLE	Contact Pilot Pin	13-85	MP-GUIDE-16
			150	MP-GUIDE-18
	NOT APPLICABLE	"Combo" Pin Contact	13-85 (Size 16)	MP-108400
		Crimp Pin Contact	150 (Size 18)	MP-108300
	NOT APPLICABLE	"Combo" Socket Contact	13-85 (Size 16)	MP-108600
		Crimp Socket Contact	150 (Size 18)	MP-108500

**NOTE:** Complete instructions for providing reliable crimped wire to contact terminations and inserting proprietary contacts in MP-41 Series connectors are available in publication P1523 located on our website [www.amphenol.com.au](http://www.amphenol.com.au).



## PART NUMBER BREAKDOWN MP-41 SERIES

### MULTIPIN CIRCULAR CONNECTORS

E. G. **MP-4106-85S**  
 Multipin, **4106** Cable Plug, **85** Contacts, **S** Female Socket Contacts,

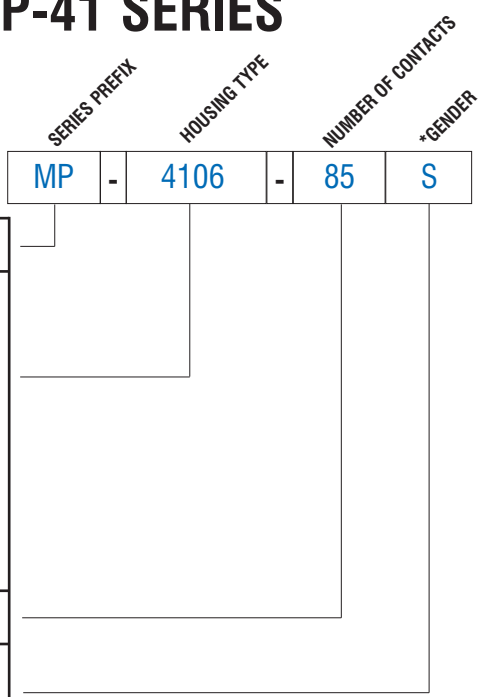

<b>SERIES PREFIX</b>	MP	=	Series Prefix
<b>HOUSING TYPE</b>	4101	=	Inline cable connecting receptacle
	4102	=	Panel receptacle
	4106	=	Cable plug
	4164	=	Panel plug
	25042S	=	Dustcap for panel plug
	25042L	=	Dustcap for cable plug
	25043S	=	Dustcap for panel receptacle
	25043L	=	Dustcap for cable receptacle
<b>NO. OF CONTACTS</b>			13, 19, 25, 37, 54, 85, 150
<b>GENDER</b> <small>*Not required for dustcaps</small>	P	=	Male pin contacts
	S	=	Female socket contacts



## STANDARD DATA MP-41 SERIES

		VALUE						
<b>GENERAL CHARACTERISTICS</b>	Number of contacts	13	19	25	37	54	85	150
	Number of channels	4	6	8	12	16	28	48
	Termination	Solder / Crimp "Combo"						Crimp
	Wire Gauge - Stranded Wire	16AWG - 20AWG						18AWG
	Environmental	Complies with RoHS Directive 2002/95/EC						
<b>ELECTRICAL CHARACTERISTICS</b>	Operating Voltage at Sea level - DC	250V*						250V*
	Operating Voltage at Sea level - AC	200V*						200V*
	Test Voltage AC RMS	1000V						1000V
	Current Carrying Capacity	13A						7.5A
	Typical Contact Resistance	3.46mΩ						11.25mΩ
	Insulation Resistance	5000MΩ						
<b>CLIMATIC CHARACTERISTICS</b>	Protection Class	IP67 (when mated)						
	Operating Temperature	-55°C to +125°C (-67°F to +257°F)						
<b>MECHANICAL CHARACTERISTICS</b>	Cable Retention	PG Gland						
	Mechanical Operations	2000 mating cycles						
<b>MATERIALS</b>	Connector / Shell Finish	Aluminium Alloy / Black						
	Insert	Synthetic Insert to MIL-R-3065						
	Male pin contact / Plating	Brass / Gold flash plated						
	Female socket contact / Plating	Brass / Gold flash plated						
<b>CLAMPING CHARACTERISTICS</b>	PG Gland	11	13.5	16	21	29	36	
	Cable Clamping range	mm	4-10	5-12	9-14	13-18	14-25	19-32
	(inches)	(0.15"-0.39")	(0.19"-0.47")	(0.35"-0.55")	(0.51"-0.70")	(0.55"-0.98")	(0.74"-1.25")	

Rev 1 - 09/2005

\*Not suitable for domestic applications above 50V





Amphenol's Multipin MP-62 series of circular connectors utilise the same design principles as the Mil-C-26482 military connectors. Featuring a three point quick mating bayonet coupling and five key polarisation ensuring a positive connection every time. Available in two contact pin layouts 39 and 61 with gold plated solder contacts fitted as standard.

**Features:**

- 39 or 61 pins.
- Gold plated solder contacts.
- Neoprene insert.
- Protective dust caps
- Environmental resistant.
- Black finish.
- Positive bayonet locking
- PG cable glands

**Specifications: Page 113    Wiring Info: Page 116**

PRODUCT - FIGURE	Dimensions in mm (inches) <b>DRAWING</b>	Dimensions in mm (inches)			PINS	PART NUMBER	PART NUMBER With Dustcap
		A	B	PG			
	Straight cable plug with pin contacts, Black finish, Gold plated solder contacts. 	38.9 (1.53)	181.5 (7.15)	16	39	MP-6216-39P	MP-6216-39P-C
		45.5 (1.80)	193 (7.60)	21	61	MP-6216-61P	MP-6216-61P-C
	Cable connecting receptacle with socket contacts, Black finish, Gold plated solder contacts. 	36.7 (1.45)	181.5 (7.15)	16	39	MP-6211-39S	MP-6211-39S-C
		43.0 (1.70)	193 (7.60)	21	61	MP-6211-61S	MP-6211-61S-C
	Straight cable plug with pin contacts, NPT 3/4" threaded backshell, Black finish, Gold plated solder contacts. 	38.9 (1.53)	90 (3.54)	NPT 3/4"	39	MP-6516-39P	MP-6516-39P-C
		45.5 (1.80)	100 (3.94)	NPT 3/4"	61	MP-6516-61P	MP-6516-61P-C
	Cable connecting receptacle with socket contacts, NPT 3/4" threaded backshell, Black finish, Gold plated solder contacts. 	36.7 (1.45)	90 (3.54)	NPT 3/4"	39	MP-6511-39S	MP-6511-39S-C
		43.0 (1.70)	100 (3.94)	NPT 3/4"	61	MP-6511-61S	MP-6511-61S-C

PRODUCT - FIGURE	Dimensions in mm (inches) <b>DRAWING</b>	Dimensions in mm (inches)						PINS	PART NUMBER	PART NUMBER With Dustcap
		A	B	C	D	E	F			
	Panel plug with pin contacts, Black finish, Gold plated solder contacts. 	38.86 (1.53)	29.36 (1.16)	6-32 UNC	39.0 (1.54)	26.5 (1.04)	-	39	MP-6256-39P	MP-6256-39P-C
		43.94 (1.73)	34.93 (1.38)	6-32 UNC	45.5 (1.80)	26.5 (1.04)	-	61	MP-6256-61P	MP-6256-61P-C
	Panel receptacle plug with socket contacts, Black finish, Gold plated solder contacts. 	36.7 (1.44)	29.36 (1.15)	3.05 (0.12)	31.8 (1.25)	22.3 (0.87)	30.1 (1.18)	39	MP-6212-39S	MP-6212-39S-C
		43.0 (1.69)	34.93 (1.38)	3.74 (0.15)	38.1 (1.50)	22.3 (0.87)	36.4 (1.43)	61	MP-6212-61S	MP-6212-61S-C



PRODUCT - FIGURE	DRAWING Dimensions in mm (inches)	DESCRIPTION	Dimensions in mm (inches)				PINS	PART NUMBER
			A	B	C	D		
		Plug protective dustcap to suit MP-6256	31.7 (1.25)	15.9 (0.62)	127 (4.99)	4.40 (0.17)	39	MP-742-39S
			38.05 (1.50)	16.70 (0.66)	127 (4.99)	4.40 (0.17)	61	MP-742-61S
		Receptacle protective dustcap to suit MP-6216	36.9 (1.45)	13.13 (0.52)	127 (4.99)	-	39	MP-742-39L
			43.14 (1.70)	14.15 (0.56)	127 (4.99)	-	61	MP-742-61L
		Plug protective dustcap to suit MP-6212	31.7 (1.25)	15.9 (0.62)	127 (4.99)	4.40 (0.17)	39	MP-738-39S
			38.05 (1.50)	16.70 (0.66)	127 (4.99)	4.40 (0.17)	61	MP-738-61S
		Receptacle protective dustcap to suit MP-6211	36.9 (1.45)	13.13 (0.52)	127 (4.99)	-	39	MP-738-39L
			43.14 (1.70)	14.15 (0.56)	127 (4.99)	-	61	MP-738-61L

## STANDARD DATA MP-62 SERIES / MP - 65 SERIES

		VALUE	
<b>GENERAL CHARACTERISTICS</b>	Number of contacts	39	61
	Number of channels	12	20
	Termination	Solder	
	Wire Gauge - Stranded Wire	37 x 24AWG-20AWG 2 x 20AWG-16AWG	24AWG-20AWG
	Environmental	Complies with RoHS Directive 2002/95/EC	
<b>ELECTRICAL CHARACTERISTICS</b>	Operating Voltage at Sea level - DC	600V*	
	Operating Voltage at Sea level - AC	600V*	
	Test Voltage AC RMS	1500V	
	Current Carrying Capacity	37 x 7.5A 2 x 13A	7.5A
	Insulation Resistance	5000M $\Omega$	
<b>CLIMATIC CHARACTERISTICS</b>	Protection Class	IP67 (when mated)	
	Operating Temperature	-55°C to +125°C (-67°F to +257°F)	
<b>MECHANICAL CHARACTERISTICS</b>	Cable Retention	PG Gland / NPT Thread	
	Mechanical Operations	500 mating cycles (minimum)	
<b>MATERIALS</b>	Connector / Shell Finish	Aluminium Alloy / Black	
	Insert	Neoprene	
	Male pin contact machined - Plating	Brass / Gold flash plated	
	Female socket contact machined - Plating	Brass / Gold flash plated	
<b>CLAMPING CHARACTERISTICS</b>	PG Gland	16	21
	Cable Clamping range mm (inches)	9-14 (0.35"-0.55")	13-18 (0.51"-0.70")

Rev 1 - 09/2005

\*Not suitable for domestic applications above 50V





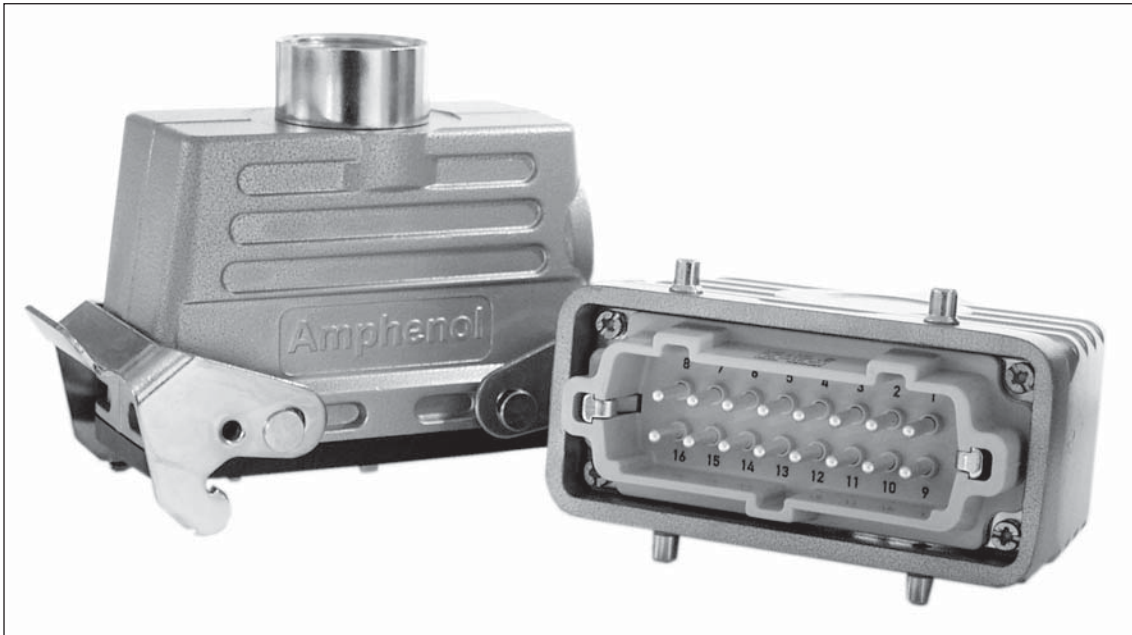

## 146 SERIES RECTANGULAR CONNECTORS

Amphenol Tuchel C146 series rectangular connectors feature modular components ensuring a vast range of different features and benefits for the end user. The zinc diecast aluminum housings are finished in a durable powder coat and available in either top or side entry. Connector coupling is achieved via a positive locking lever ensuring a positive rapid connection. The C146 series is suitable for general-purpose audio and lighting applications and is completely intermateable with all competitor connectors.

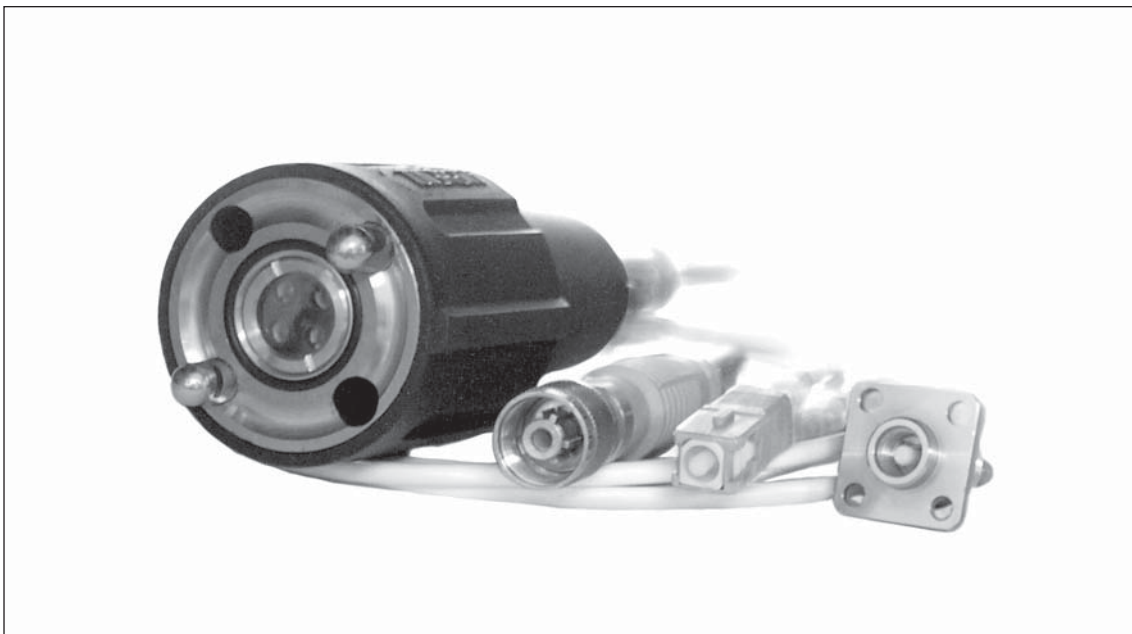

## FIBRE OPTIC

Amphenol has over 20 years experience in fibre optics dating back to their development of the first industry standard connector, the SMA. Amphenol's range has since broadened to include popular connector types, cable assemblies, couplers, wave division multiplexers, attenuators and adapters. Amphenol's experience also lead to the development of a large range of ruggedised connectors for harsh environment applications.

## CONNECTOR WIRING INFORMATION

### XLR (Microphone / Patch Cables)

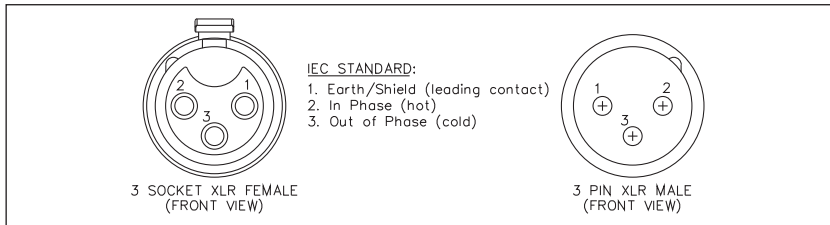

The standard XLR 3 contact pin outs are as shown above for a balanced lead. In such a configuration audio “Hot” (pin 2) is the in-phase connection whilst audio “Cold” (pin 3) is the out-of-phase connection. For an unbalanced lead however, you may connect pin 1 to either pin 2 or pin 3, but not both. In such a configuration the remaining pin is used for the audio signal.

When terminating the cable shielding to pin 1 it is suggested that the shield be only grounded at one end of the cable to avoid inducing “hum”. Pin 1 is a leading contact that engages at interconnection, before pin 2 or pin 3.

### PDN (Speaker Cables)

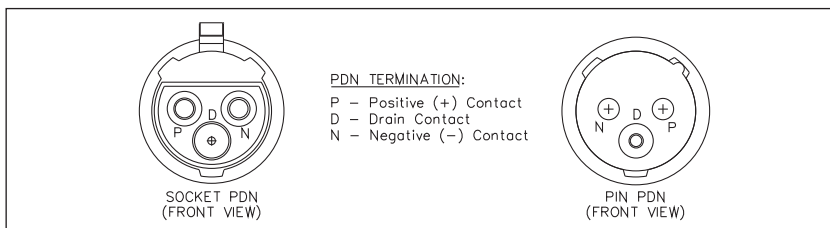

The PDN stands for Positive, Drain and Negative. P pin is used for the Positive (+) line and the N pin is for the return line. D pin is a leading contact that engages at interconnection, before the major contacts. If applicable, solder the cable screen to this contact.

### 1/4” Phono (6.35mm) (Standard Applications)

#### MICROPHONE CABLE - BALANCED

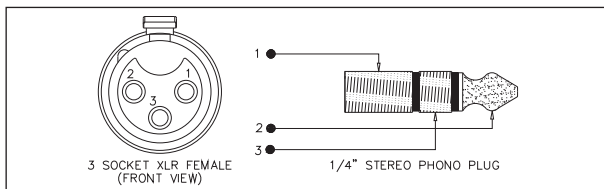

#### MICROPHONE CABLE - UNBALANCED

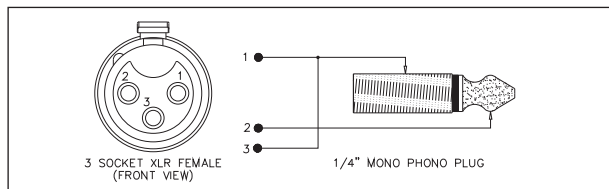

#### INSTRUMENT / LINE CABLE (MONO)

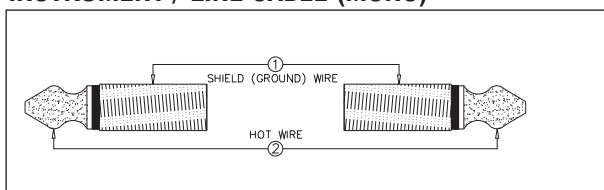

#### INSTRUMENT / LINE CABLE (STEREO)

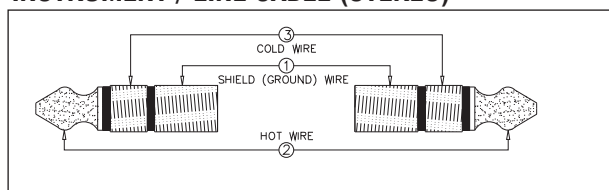

# Amphenol

## CONNECTOR WIRING INFORMATION

### MP Series

MP-41 Series  
4 Ch - 13 pin

Ch	+	-	G
1	B	C	E
2	F	K	H
3	J	D	A
4	N	M	G
General			
Ground	L		

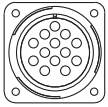

MP-41 Series  
6 Ch - 19 pin

Ch	+	-	G
1	L	M	U
2	A	N	B
3	K	J	T
4	V	P	C
5	H	S	G
6	R	D	E
General			
Ground	F		

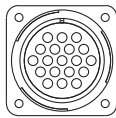

MP-41 Series  
8 Ch - 25 pin

Ch	+	-	G
1	A	E	F
2	G	C	B
3	D	H	J
4	M	L	K
5	Q	P	N
6	W	S	R
7	T	X	Y
8	Z	V	U
General			
Ground	a		

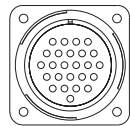

MP-41 Series  
12 Ch - 37 pin

Ch	+	-	G
1	E	F	A
2	B	C	G
3	H	J	D
4	S	T	K
5	L	M	U
6	V	W	N
7	P	R	X
8	a	b	g
9	c	d	j
10	e	f	m
11	n	p	h
12	r	s	k
General			
Ground	z		

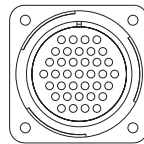

MP-41 Series  
16 Ch - 54 pin

Ch	+	-	G
1	W	f	r
2	J	R	a
3	k	v	AC
4	E	M	V
5	e	q	y
6	B	H	P
7	Z	j	u
8	D	L	U
9	d	p	x
10	A	G	O
11	Y	h	t
12	C	K	T
13	c	n	w
14	F	N	X
15	g	s	AB
16	S	b	m
General			
Ground	AG		

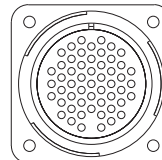

MP-41 Series  
28 Ch - 85 pin

Ch	+	-	G
1	A	B	C
2	E	F	H
3	J	K	L
4	N	P	R
5	S	T	U
6	X	Y	Z
7	a	b	c
8	d	f	g
9	h	i	j
10	k	m	n
11	p	q	r
12	t	u	v
13	w	x	y
14	z	AA	AB
15	AC	AD	AE
16	AF	AH	AJ
17	AK	AL	AM
18	AP	AR	AS
19	AT	AU	AV
20	AW	AX	AY
21	AZ	BA	BB
22	BC	BD	BE
23	BJ	BK	BL
24	BM	BN	BP
25	BS	BT	BU
26	BV	BR	BF
27	BH	AN	s
28	W	M	D
General			
Ground	V		

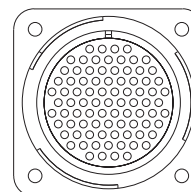

MP-41 Series  
48 Ch - 150 pin

Ch	+	-	G
1	1	2	3
2	5	6	7
3	8	9	10
4	11	12	13
5	14	15	16
6	17	18	19
7	21	22	23
8	24	25	26
9	27	28	29
10	20	30	31
11	32	33	34
12	35	36	37
13	38	39	40
14	41	42	43
15	44	45	46
16	47	48	49
17	50	51	52
18	53	54	55
19	57	58	59
20	60	61	62
21	63	64	65
22	66	67	68
23	69	70	71
24	72	73	74
25	75	76	77
26	78	79	80
27	82	83	84
28	85	86	87
29	88	89	90
30	91	92	93
31	94	95	96
32	97	98	99
33	100	101	102
34	103	104	105
35	56	81	106
36	107	108	109
37	110	111	112
38	113	114	115
39	116	117	118
40	119	120	121
41	122	123	124
42	125	126	127
43	139	128	129
44	130	131	132
45	133	134	135
46	136	137	138
47	140	141	142
48	143	144	145
General			
Ground	150		

MP-62 Series  
12 Ch - 39 pin

Ch	+	-	G
1	p	n	q
2	W	A	X
3	N	f	P
4	L	e	M
5	J	d	K
6	G	c	H
7	E	b	F
8	D	a	Z
9	C	B	Y
10	U	j	V
11	i	h	T
12	R	g	S
General			
Ground	N/A		

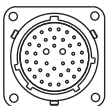

MP-62 Series  
20 Ch - 61 pin

Ch	+	-	G
1	JJ	HH	NN
2	MM	KK	PP
3	BB	AA	CC
4	s	FF	W
5	r	EE	V
6	e	D	x
7	f	E	y
8	q	DD	U
9	S	p	T
10	P	N	R
11	m	k	n
12	L	K	M
13	J	i	j
14	H	G	h
15	g	F	z
16	d	C	w
17	B	A	c
18	b	a	Z
19	v	u	Y
20	t	GG	X
General			
Ground	N/A		

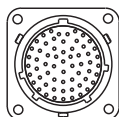

Part Number	Page	Part Number	Page	Part Number	Page	Part Number	Page	Part Number	Page
112119	83	AC3FBH1-AU-B	40	AC3FJ	10	AC3MBJ	10	AC3MMP BULK	26
112133	83	AC3FBH2-AU-B	40	AC3FPP	60	AC3MBV1-AU-B	40	AC3MMP-AU	26
112507	83	AC3FBH3-AU-B	40	AC3FPP BULK	60	AC3MBV2-AU-B	40	AC3MMPB	26
112508	83	AC3FBHB-AU-B	40	AC3FPPH	60	AC3MBV3-AU-B	40	AC3MMPB BULK	26
112509	83	AC3FBHB1-AU-B	40	AC3FPPH BULK	60	AC3MBV-AU-B	39	AC3MMPB-AU	26
112519	83	AC3FBHB2-AU-B	40	AC3FPPHL	60	AC3MBVB1-AU-B	40	AC3MMPNZ	26
112521	83	AC3FBHB3-AU-B	40	AC3FPPHL BULK	60	AC3MBVB2-AU-B	40	AC3MMPNZ BULK	26
112565	83	AC3FBHB-AU-B	40	AC3FPPI	62	AC3MBVB3-AU-B	40	AC3MMPNZ-AU	26
112606	83	AC3FBHBL1-AU-B	41	AC3FPPI BULK	62	AC3MBVB-AU-B	39	AC3MMPNZB	26
112950	83	AC3FBHBL2-AU-B	41	AC3FPPI BULK	62	AC3MCP	14	AC3MMPNZB BULK	26
112951	83	AC3FBHBL3-AU-B	41	AC3FPPI BULK	62	AC3MCP BULK	14	AC3MMPNZB-AU	26
112952	83	AC3FBHBL-AU-B	40	AC3FPPL	60	AC3MCP-AU	14	AC3MMPNZV	26
112953	83	AC3FBHL1-AU-B	41	AC3FPPL BULK	60	AC3MCP	18	AC3MMPNZVB	26
112955	83	AC3FBHL2-AU-B	41	AC3FPPV	60	AC3MCP	18	AC3MMPV	26
112956	83	AC3FBHL3-AU-B	41	AC3FPPV BULK	60	AC3MCP-AU	18	AC3MMPVB	26
112957	83	AC3FBHL-AU-B	40	AC3FPPVL	60	AC3MCPJ	14	AC3MMR	15
47009	84	AC3FBJ	10	AC3FPPVL BULK	60	AC3MDP	58	AC3MP	27
47-10070	84	AC3FBV1-AU-B	41	AC3FPZ	27	AC3MDP BULK	58	AC3MP BULK	27
47-10100	84	AC3FBV2-AU-B	41	AC3FPZ BULK	27	AC3MDPH	58	AC3MP-AU	27
47-10110	84	AC3FBV3-AU-B	41	AC3FPZ-AU	27	AC3MDPH BULK	58	AC3MPB	27
47-10150	84	AC3FBV-AU-B	41	AC3FPZB	27	AC3MDPHL	58	AC3MPB BULK	27
47-10200	84	AC3FBVB1-AU-B	41	AC3FPZB BULK	27	AC3MDPHL BULK	58	AC3MPB-AU	27
47-10220	84	AC3FBVB2-AU-B	41	AC3FPZ-AU	27	AC3MDPI	62	AC3MPNZ	26
47-10230	84	AC3FBVB3-AU-B	41	AC3FPZV	27	AC3MDPI BULK	62	AC3MPNZ BULK	26
47-10240	84	AC3FBVB-AU-B	41	AC3FPZVB	27	AC3MDPI BULK	62	AC3MPNZ-AU	26
52500002-734	79	AC3FBVBL1-AU-B	42	AC3FR	15	AC3MDPIL	62	AC3MPNZB	26
52500005-732	79	AC3FBVBL2-AU-B	42	AC3M	10	AC3MDPIL BULK	62	AC3MPNZB BULK	26
AC3F	10	AC3FBVBL3-AU-B	42	AC3M BULK	10	AC3MDPL	58	AC3MPNZB-AU	26
AC3F BULK	10	AC3FBVBL-AU-B	41	AC3M3FPP	66	AC3MDPV	58	AC3MPNZV	26
AC3F3FBW	79	AC3FBVL1-AU-B	42	AC3M3FPPH	66	AC3MDPV BULK	58	AC3MPNZVB	26
AC3F3FPP	65	AC3FBVL2-AU-B	42	AC3M3FPPHL	66	AC3MDPVL	58	AC3MPP	60
AC3F3FPPH	65	AC3FBVL3-AU-B	42	AC3M3FPPH	66	AC3MDPVL BULK	58	AC3MPP BULK	60
AC3F3FPPHL	65	AC3FBVL-AU-B	41	AC3M3FPPV	66	AC3MDZ	23	AC3MPPH	60
AC3F3FPPI	63	AC3FCP	14	AC3M3FPPVL	66	AC3MDZ BULK	23	AC3MPPH BULK	60
AC3F3FPPI BULK	63	AC3FCP BULK	14	AC3M3MBW	79	AC3MDZ-AU	23	AC3MPPHL	60
AC3F3FPPL	65	AC3FCP-AU	14	AC3M3MPP	65	AC3MDZB	23	AC3MPPHL BULK	60
AC3F3FPPL BULK	65	AC3FCP-AU	14	AC3M3MPPH	65	AC3MDZB BULK	23	AC3MPPI	62
AC3F3FPPV	66	AC3FCPI	18	AC3M3MPPH	65	AC3MDZB-AU	23	AC3MPPI BULK	62
AC3F3FPPVL	66	AC3FCPI BULK	18	AC3M3MPPHL	65	AC3MDZB-AU	23	AC3MPPI BULK	62
AC3F3FW	79	AC3FCPI-AU	18	AC3M3MPPI	63	AC3MDZV	23	AC3MPPI BULK	62
AC3F3MBW	79	AC3FCPJ	14	AC3M3MPPI BULK	63	AC3MDZVB	23	AC3MPPI BULK	62
AC3F3MPP	66	AC3FCPR	15	AC3M3MPPL	65	AC3MI	16	AC3MPPL	60
AC3F3MPPH	66	AC3FDP	58	AC3M3MPPV	65	AC3MI BULK	16	AC3MPPL BULK	60
AC3F3MPPHL	66	AC3FDP BULK	58	AC3M3MPPVL	65	AC3MI-AU	16	AC3MPPV	60
AC3F3MPPI	63	AC3FDPH	58	AC3M3MW	79	AC3MIB	16	AC3MPPV BULK	60
AC3F3MPPI BULK	63	AC3FDPH BULK	58	AC3M5FW	79	AC3MIB BULK	16	AC3MPPVL	60
AC3F3MPPL	66	AC3FDPHL	58	AC3MA-AU-B	38	AC3MIB-AU	16	AC3MPPVL BULK	60
AC3F3MPPV	66	AC3FDPHL BULK	58	AC3MAH1-AU-B	35	AC3MJ	10	AC3MPV	27
AC3F3MPPVL	66	AC3FDPI	62	AC3MAH2-AU-B	35	AC3MM	10	AC3MPVB	27
AC3F3MW	79	AC3FDPI BULK	62	AC3MAH3-AU-B	35	AC3MM BULK	10	AC4F	11
AC3F5MW	79	AC3FDPI BULK	62	AC3MAH4-AU-B	35	AC3MM-AU	10	AC4F BULK	11
AC3FAH1-AU-B	36	AC3FDPI BULK	62	AC3MAH-AU-B	35	AC3MMB	10	AC4F-AU	11
AC3FAH2-AU-B	36	AC3FDPL	58	AC3M-AU	10	AC3MMB BULK	10	AC4FB	11
AC3FAH3-AU-B	36	AC3FDPL BULK	58	AC3MAV1-AU-B	36	AC3MMB-AU	10	AC4FB BULK	11
AC3FAH-AU-B	36	AC3FDPV	58	AC3MAV2-AU-B	36	AC3MMBJ	10	AC4FB-AU	11
AC3FAHL1-AU-B	37	AC3FDPV BULK	58	AC3MAV3-AU-B	36	AC3MMCP	14	AC4FBJ	11
AC3FAHL2-AU-B	37	AC3FDPVL	58	AC3MAV4-AU-B	36	AC3MMCP BULK	14	AC4FCPR	15
AC3FAHL3-AU-B	37	AC3FDPVL BULK	58	AC3MAV-AU-B	35	AC3MMCP-AU	14	AC4FDZ	24
AC3FAHL-AU-B	37	AC3FDZ	23	AC3MB	10	AC3MMCPJ	14	AC4FDZ BULK	24
AC3F-AU	10	AC3FDZ BULK	23	AC3MB BULK	10	AC3MMCP	15	AC4FDZ-AU	24
AC3FAV1-AU-B	37	AC3FDZ-AU	23	AC3MB-AU	10	AC3MMDZ	23	AC4FDZB	24
AC3FAV2-AU-B	37	AC3FDZB	23	AC3MBH1-AU-B	39	AC3MMDZ BULK	23	AC4FDZB BULK	24
AC3FAV3-AU-B	37	AC3FDZB BULK	23	AC3MBH2-AU-B	39	AC3MMDZ-AU	23	AC4FDZB-AU	24
AC3FAV-AU-B	37	AC3FDZB-AU	23	AC3MBH3-AU-B	39	AC3MMDZB	23	AC4FDZV	24
AC3FAVL1-AU-B	38	AC3FDZV	23	AC3MBH-AU-B	39	AC3MMDZB BULK	23	AC4FDZVB	24
AC3FAVL2-AU-B	38	AC3FDZVB	23	AC3MBH1-AU-B	39	AC3MMDZB-AU	23	AC4FJ	11
AC3FAVL3-AU-B	38	AC3FI	16	AC3MBH2-AU-B	39	AC3MMDZB-AU	23	AC4FPZ	28
AC3FAVL-AU-B	38	AC3FI BULK	16	AC3MBH3-AU-B	39	AC3MMDZV	23	AC4FPZ BULK	28
AC3FB	10	AC3FI-AU	16	AC3MBHB-AU-B	39	AC3MMDZVB	23	AC4FPZ-AU	28
AC3FB BULK	10	AC3FIB	16	AC3MBHL-AU-B	39	AC3MMJ	10	AC4FPZB	28
AC3FB-AU	10	AC3FIB-AU	16	AC3MBHL-AU-B	39	AC3MMP	26	AC4FPZB BULK	28



# Amphenol

Part Number	Page	Part Number	Page	Part Number	Page	Part Number	Page	Part Number	Page
AC4FPZB-AU	28	AC5M-AU	11	AC6AMDZB	25	AC-BNC20A	85	ACJM-MHDC	96
AC4FPZV	28	AC5MAV-AU-B	43	AC6AMDZB BULK	25	AC-BNC20AJ75	85	ACJM-MHDE	96
AC4FPZVB	28	AC5MB	11	AC6AMDZB-AU	25	AC-BNC20AP75	85	ACJM-MHDR	96
AC4FR	15	AC5MB BULK	11	AC6AMDZV	25	AC-BNC20B	85	ACJM-MHOM	97
AC4M	11	AC5MB-AU	11	AC6AMDZVB	25	AC-BNC20BJ75	85	ACJM-MHOP	97
AC4M BULK	11	AC5MBJ	11	AC6AMJ	12	AC-BNC20BP75	85	ACJM-MHR	97
AC4M-AU	11	AC5MCPR	15	AC6AMP	29	AC-BNC20M	85	ACJM-MHS	97
AC4MB	11	AC5MDZ	24	AC6AMP BULK	29	AC-BNC20MJ75	85	ACJM-MN-2	98
AC4MB BULK	11	AC5MDZ BULK	24	AC6AMP-AU	29	AC-BNC20MP75	85	ACJM-MN-2S	98
AC4MB-AU	11	AC5MDZ-AU	24	AC6AMPB	29	AC-BNC40A	85	ACJM-MV	98
AC4MBJ	11	AC5MDZB	24	AC6AMPB BULK	29	AC-BNC40AJ75	85	ACJM-MVD985-2S	98
AC4MCPR	15	AC5MDZB BULK	24	AC6AMPB-AU	29	AC-BNC40AP75	85	ACJM-MVD985-S	98
AC4MDZ	24	AC5MDZB-AU	24	AC6AMPNZ	29	AC-BNC40B	85	ACJM-NH35	96
AC4MDZ BULK	24	AC5MDZV	24	AC6AMPNZ BULK	29	AC-BNC40BJ75	85	ACJM-NV35-2	98
AC4MDZ-AU	24	AC5MDZVB	24	AC6AMPNZ-AU	29	AC-BNC40BP75	85	ACJM-NV35-2S	98
AC4MDZB	24	AC5MJ	11	AC6AMPNZB	29	AC-BNC40M	85	ACJM-PC	97
AC4MDZB BULK	24	AC5MP	28	AC6AMPNZB BULK	29	AC-BNC40MJ75	85	ACJM-PH	97
AC4MDZB-AU	24	AC5MP BULK	28	AC6AMPNZB-AU	29	AC-BNC40MP75	85	ACJM-PHOM	97
AC4MDZV	24	AC5MP-AU	28	AC6AMPNZV	29	AC-BNC-JJ-75	84	ACJM-PHOP	97
AC4MDZVB	24	AC5MPB	28	AC6AMPNZVB	29	AC-BNC-JJ-75B	84	ACJM-PHR	97
AC4MJ	11	AC5MPB BULK	28	AC6AMPV	29	AC-BNC-JJA-75	84	ACJM-PHS	98
AC4MP	27	AC5MPB-AU	28	AC6AMPVB	29	AC-BNC-JS-75	84	ACJM-PVB-2	98
AC4MP BULK	27	AC5MPNZ	28	AC6AMR	15	AC-BNC-JS-75B	84	ACJM-PVB-2S	98
AC4MP-AU	27	AC5MPNZ BULK	28	AC7F	12	AC-BNC-PJ-75	84	ACJR-BLK	102
AC4MPB	27	AC5MPNZ-AU	28	AC7F BULK	12	AC-BNC-PJ-75B	84	ACJR-BLU	102
AC4MPB BULK	27	AC5MPNZB	28	AC7FB	12	AC-BNC-PJA-75	84	ACJR-GRN	102
AC4MPB-AU	27	AC5MPNZB BULK	28	AC7FB BULK	12	AC-GROMMET-BLU	80	ACJR-RED	102
AC4MPNZ	27	AC5MPNZB-AU	28	AC7FBJ	12	AC-GROMMET-BRN	80	ACJR-WHT	102
AC4MPNZ BULK	27	AC5MPNZV	28	AC7FCPR	15	AC-GROMMET-GRN	80	ACJR-YEL	102
AC4MPNZ-AU	27	AC5MPNZVB	28	AC7FDZ	25	AC-GROMMET-GRY	80	ACJS-IH	97
AC4MPNZB	27	AC5MPV	28	AC7FDZ BULK	25	AC-GROMMET-ORG	80	ACJS-MC	97
AC4MPNZB BULK	27	AC5MPVB	28	AC7FDZB	25	AC-GROMMET-RED	80	ACJS-MH	97
AC4MPNZB-AU	27	AC5MR	15	AC7FDZB BULK	25	AC-GROMMET-VIO	80	ACJS-MHD	96
AC4MPNZV	27	AC6AF	12	AC7FDZV	25	AC-GROMMET-WHT	80	ACJS-MHD985	96
AC4MPNZVB	27	AC6AF BULK	12	AC7FDZVB	25	AC-GROMMET-YEL	80	ACJS-MHDC	96
AC4MPV	27	AC6AF-AU	12	AC7FJ	12	ACJC10H BULK	53	ACJS-MHDE	96
AC4MPVB	27	AC6AFB	12	AC7FPZ	30	ACJC10HL BULK	53	ACJS-MHDR	96
AC4MR	15	AC6AFB BULK	12	AC7FPZ BULK	30	ACJC10S BULK	54	ACJS-MHOM	97
AC5F	11	AC6AFB-AU	12	AC7FPZB	30	ACJC10SL BULK	54	ACJS-MHOP	97
AC5F BULK	11	AC6AFBJ	12	AC7FPZB BULK	30	ACJC10V BULK	53	ACJS-MHR	97
AC5FAH-AU-B	43	AC6AFCPR	15	AC7FPZV	30	ACJC10VL BULK	53	ACJS-MHS	98
AC5F-AU	11	AC6AFDZ	25	AC7FR	15	ACJC5H BULK	51	ACJS-MN-3	98
AC5FAV-AU-B	43	AC6AFDZ BULK	25	AC7M	12	ACJC5HL BULK	51	ACJS-MN-3S	98
AC5FB	11	AC6AFDZ-AU	25	AC7MB	12	ACJC5S BULK	51	ACJS-MN-5	98
AC5FB BULK	11	AC6AFDZB	25	AC7MB BULK	12	ACJC5SL BULK	51	ACJS-MV	98
AC5FB-AU	11	AC6AFDZB BULK	25	AC7MB BULK	12	ACJC5V BULK	51	ACJS-MVD985-3	98
AC5FBJ	11	AC6AFDZB-AU	25	AC7MBJ	12	ACJC5VL BULK	51	ACJS-MVD985-3S	98
AC5FCPR	15	AC6AFDZV	25	AC7MCPR	15	ACJC6H BULK	52	ACJS-MVD985-5	98
AC5FDZ	24	AC6AFDZVB	25	AC7MDZ	25	ACJC6HL BULK	52	ACJS-NH35	96
AC5FDZ BULK	24	AC6AFJ	12	AC7MDZ BULK	25	ACJC6S BULK	52	ACJS-NV35-3	98
AC5FDZ-AU	24	AC6AFPZ	29	AC7MDZB	25	ACJC6SL BULK	52	ACJS-NV35-3S	98
AC5FDZB	24	AC6AFPZ BULK	29	AC7MDZB BULK	25	ACJC6V BULK	52	ACJS-NV35-5	98
AC5FDZB BULK	24	AC6AFPZ-AU	29	AC7MDZV	25	ACJC6VL BULK	52	ACJS-PC	97
AC5FDZB-AU	24	AC6AFPZB	29	AC7MDZVB	25	ACJC9H BULK	52	ACJS-PH	97
AC5FDZV	24	AC6AFPZB BULK	29	AC7MJ	12	ACJC9HL BULK	52	ACJS-PHOM	97
AC5FJ	11	AC6AFPZB-AU	29	AC7MP	30	ACJC9S BULK	53	ACJS-PHOP	97
AC5FPZ	28	AC6AFPZV	29	AC7MP BULK	30	ACJC9SL BULK	53	ACJS-PHR	97
AC5FPZ BULK	28	AC6AFR	15	AC7MP BULK	30	ACJC9V BULK	53	ACJS-PHS	97
AC5FPZ-AU	28	AC6AM	12	AC7MPB	30	ACJC9VL BULK	53	ACJS-PVB-3	98
AC5FPZB	28	AC6AM BULK	12	AC7MPB BULK	30	ACJD-BLK	98	ACJS-PVB-3S	98
AC5FPZB BULK	28	AC6AM-AU	12	AC7MPNZ	29	ACJD-BLU	98	ACJS-PVB-5	98
AC5FPZB-AU	28	AC6AMB	12	AC7MPNZ BULK	29	ACJD-GRN	102	AC-NUT-BLU	80
AC5FPZV	28	AC6AMB BULK	12	AC7MPNZB	29	ACJD-RED	102	AC-NUT-BRN	80
AC5FPZVB	28	AC6AMB-AU	12	AC7MPNZB BULK	29	ACJD-WHT	102	AC-NUT-GRN	80
AC5FR	15	AC6AMB-AU	12	AC7MPNZV	29	ACJD-YEL	102	AC-NUT-GRY	80
AC5M	11	AC6AMBJ	12	AC7MPNZVB	29	ACJM-IH	97	AC-NUT-J-BLK	81
AC5M BULK	11	AC6AMCPR	15	AC7MPV	30	ACJM-MC	97	AC-NUT-METAL	81
AC5M5MW	79	AC6AMDZ	25	AC7MPVB	30	ACJM-MH	97	AC-NUT-ORG	80
AC5MAH-AU-B	43	AC6AMDZ BULK	25	AC7MR	15	ACJM-MHD	96	AC-NUT-RED	80
		AC6AMDZ-AU	25	AC-BNC LABEL	85	ACJM-MHD985	96		





Part Number	Page	Part Number	Page	Part Number	Page	Part Number	Page	Part Number	Page
AC-NUT-VIO	80	AG6MCC	103	EP-4-11PB	74	MP-25043-54S	107	MP-6216-61P	111
AC-NUT-WHT	80	AP-4-11	76	EP-4-12	74	MP-25043-85L	107	MP-6216-61P-C	111
AC-NUT-YEL	80	AP-4-12	76	EP-4-12B	74	MP-25043-85S	107	MP-6256-39P	111
AC-PDN-11-BLU	71	AP-4-13	76	EP-4-13P	75	MP-4101-13P	105	MP-6256-39P-C	111
AC-PDN-11-WHT	71	AP-4-14	76	EP-4-13PB	75	MP-4101-13P-C	105	MP-6256-61P	111
AC-PDN-12-BLU	71	AP-4-21	76	EP-4-14	75	MP-4101-150P	105	MP-6256-61P-C	111
AC-PDN-12-WHT	71	AP-4-22	76	EP-4-14B	75	MP-4101-150P-C	105	MP-6511-39S	111
AC-PDN-31-BLU	71	AP-5-11	76	EP-5-11P	74	MP-4101-19P	105	MP-6511-39S-C	111
AC-PDN-31-WHT	71	AP-5-12	76	EP-5-11PB	74	MP-4101-19P-C	105	MP-6511-61S	111
AC-PDN-34-BLU	71	AP-5-13	76	EP-5-12	74	MP-4101-25P	105	MP-6511-61S-C	111
AC-PDN-34-WHT	71	AP-5-14	76	EP-5-12B	74	MP-4101-25P-C	105	MP-6516-39P	111
ACPM-GB	94	AP-5-21	76	EP-5-13P	75	MP-4101-37P	105	MP-6516-39P-C	111
ACPM-GB BULK	94	AP-5-22	76	EP-5-13PB	75	MP-4101-37P-C	105	MP-6516-61P	111
ACPM-GB-AU	94	AP-6-11	76	EP-5-14	75	MP-4101-54P	105	MP-6516-61P-C	111
ACPM-GN	94	AP-6-12	76	EP-5-14B	75	MP-4101-54P-C	105	MP-738-39L	112
ACPM-GN BULK	94	AP-6-13	76	EP-6-11P	74	MP-4101-85P	105	MP-738-39S	112
ACPM-GN-AU	94	AP-6-14	76	EP-6-11PB	74	MP-4101-85P-C	105	MP-738-61L	112
ACPM-RB	95	AP-6-21	76	EP-6-12	74	MP-4102-13S	106	MP-738-61S	112
ACPM-RB BULK	95	AP-6-22	76	EP-6-12B	74	MP-4102-13S-C	106	MP-742-39L	112
ACPM-RB-AU	95	AP-8-11	76	EP-6-13P	75	MP-4102-150S	106	MP-742-39S	112
ACPM-RN	95	AP-8-12	76	EP-6-13PB	75	MP-4102-150S-C	106	MP-742-61L	112
ACPM-RN BULK	95	AP-8-13	76	EP-6-14	75	MP-4102-19S	106	MP-742-61S	112
ACPM-RN-AU	95	AP-8-14	76	EP-6-14B	75	MP-4102-19S-C	106	MP-EXT-16/18	108
ACPR-BLK	102	AP-8-21	76	EP-8-11P	74	MP-4102-25S	106	MP-GUIDE-16	108
ACPR-BLU	102	AP-8-22	76	EP-8-11PB	74	MP-4102-25S-C	106	MP-GUIDE-18	108
ACPR-GRN	102	AX3F	4	EP-8-12	74	MP-4102-37S	106	MP-INS-16	108
ACPR-RED	102	AX3F BULK	4	EP-8-12B	74	MP-4102-37S-C	106	MP-INS-18	108
ACPR-WHT	102	AX3F-AU	4	EP-8-13P	75	MP-4102-54S	106	T2860	79
ACPR-YEL	102	AX3FB	4	EP-8-13PB	75	MP-4102-54S-C	106	T2880	79
ACPS-GB	94	AX3FB BULK	4	EP-8-14	75	MP-4102-85S	106	T2890	79
ACPS-GB BULK	94	AX3FB-AU	4	EP-8-14B	75	MP-4102-85S-C	106	TH29-1	108
ACPS-GB-AU	94	AX3M	4	JM2P	91	MP-4106-13S	105	TM2P	89
ACPS-GN	94	AX3M BULK	4	JM2P BULK	91	MP-4106-13S-C	105	TM2P BULK	89
ACPS-GN BULK	94	AX3M-AU	4	JM2P-AU	91	MP-4106-150S	105	TM2P-AU	89
ACPS-GN-AU	94	AX3MB	4	JM2PB	91	MP-4106-150S-C	105	TM2PB	89
ACPS-RB	95	AX3MB BULK	4	JM2PB BULK	91	MP-4106-19S	105	TM2PB BULK	89
ACPS-RB BULK	95	AX3MB-AU	4	JM2PB-AU	91	MP-4106-19S-C	105	TM2PB-AU	89
ACPS-RB-AU	95	AX-BOOT	80	JS3P	91	MP-4106-25S	105	TM2PBJ	89
ACPS-RN	95	AX-BOOT-1	80	JS3P BULK	91	MP-4106-25S-C	105	TM2PBM	90
ACPS-RN BULK	95	AX-BOOT-2	80	JS3P-AU	91	MP-4106-37S	105	TM2PBM BULK	90
ACPS-RN-AU	95	AX-BOOT-3	80	JS3PB	91	MP-4106-37S-C	105	TM2PBM-AU	90
AC-RING-BLU	81	AX-BOOT-4	80	JS3PB BULK	91	MP-4106-54S	105	TM2PBMJ	90
AC-RING-BLU-PK1	81	AX-BOOT-5	80	JS3PB-AU	91	MP-4106-54S-C	105	TM2PJ	89
AC-RING-BLU-PK2	81	AX-BOOT-6	80	M22520/1-01	108	MP-4106-85S	105	TM2PM	90
AC-RING-BRN	81	AX-BOOT-7	80	MP-108300	108	MP-4106-85S-C	105	TM2PMJ	90
AC-RING-GRN	81	AX-BOOT-8	80	MP-108400	108	MP-4164-13S	106	TM2PN	90
AC-RING-GRY	81	AX-BOOT-9	80	MP-108500	108	MP-4164-13S-C	106	TM2PN BULK	90
AC-RING-ORG	81	AX-BOOT-CLR	80	MP-108600	108	MP-4164-150S	106	TM2PN-AU	90
AC-RING-RED	81	AX-SLEEVE	80	MP-25042-13L	106	MP-4164-150S-C	106	TM2PNJ	90
AC-RING-RED-PK1	81	AX-SLEEVE-1	80	MP-25042-13S	106	MP-4164-19S	106	TS3P	89
AC-RING-RED-PK2	81	AX-SLEEVE-2	80	MP-25042-19L	106	MP-4164-19S-C	106	TS3P BULK	89
AC-RING-VIO	81	AX-SLEEVE-3	80	MP-25042-19S	106	MP-4164-25S	106	TS3P-AU	89
AC-RING-WHT	81	AX-SLEEVE-4	80	MP-25042-25L	106	MP-4164-25S-C	106	TS3PB	89
AC-RING-YEL	81	AX-SLEEVE-5	80	MP-25042-25S	106	MP-4164-37S	106	TS3PB BULK	89
AC-RING-YEL-PK1	81	AX-SLEEVE-6	80	MP-25042-37L	106	MP-4164-37S-C	106	TS3PB-AU	89
AC-RING-YEL-PK2	81	AX-SLEEVE-7	80	MP-25042-37S	106	MP-4164-54S	106	TS3PBJ	89
AG3F	103	AX-SLEEVE-8	80	MP-25042-54L	106	MP-4164-54S-C	106	TS3PBM	90
AG3FCRV	103	AX-SLEEVE-9	80	MP-25042-54S	106	MP-4164-85S	106	TS3PBM BULK	90
AG3M	103	AX-SLEEVE-CLR	80	MP-25042-85L	106	MP-4164-85S-C	106	TS3PBM-AU	90
AG3MCC	103	BNC-U-LINK 75*1	84	MP-25042-85S	106	MP-6211-39S	111	TS3PBMJ	90
AG4F	103	EP-3-11P	74	MP-25043-13L	107	MP-6211-39S-C	111	TS3PJ	89
AG4FCRV	103	EP-3-11PB	74	MP-25043-13S	107	MP-6211-61S	111	TS3PM	90
AG4M	103	EP-3-12	74	MP-25043-19L	107	MP-6211-61S-C	111	TS3PMJ	90
AG4MCC	103	EP-3-12B	74	MP-25043-19S	107	MP-6212-39S	111	TS3PN	90
AG5F	103	EP-3-13P	75	MP-25043-25L	107	MP-6212-39S-C	111	TS3PN BULK	90
AG5M	103	EP-3-13PB	75	MP-25043-25S	107	MP-6212-61S	111	TS3PN-AU	90
AG5MCC	103	EP-3-14	75	MP-25043-37L	107	MP-6212-61S-C	111	TS3PNJ	90
AG6F	103	EP-3-14B	75	MP-25043-37S	107	MP-6216-39P	111		
AG6M	103	EP-4-11P	74	MP-25043-54L	107	MP-6216-39P-C	111		





## PRODUCT SAFETY INFORMATION

This should be read in conjunction with Data Sheet information contained in individual product brochures. Failure to observe the advice in this information sheet and the operating conditions specified in the Data Sheets could result in hazardous situations.

### 1. Material Content and Physical Form

Electrical connectors do not usually contain hazardous materials. They contain conducting and non-conducting materials. Shells are manufactured in metal and plastic. Insulators can be formed in either natural rubber, synthetic rubber, plastic or glass insulating materials. Contact materials vary with the type of connector and its application. They are usually manufactured from either copper alloys, nickel, alumel, chromel or steel. In special applications, other alloys may be specified.

### 2. Fire Characteristics and Electric Shock Hazard

There is no fire hazard when the connector is correctly wired and used within the specified parameters. Incorrect wiring or assembly of the connector or careless use of metal tools or conductive fluids, or transit damage to any of the component parts may cause electric shock or burns. Live circuits must not be broken by separating mated connectors as this may cause arcing, ionisation and burning. Heat dissipation is greater at maximum resistance in a circuit. Hot spots may occur when resistance is raised locally by damage, e.g. cracked or deformed contacts, or broken strands of wire. Local overheating may also result from the use of the incorrect application tools or from poor quality soldering.

Overheating may occur if the ratings in the Data Sheets are exceeded and can cause breakdown of insulation and hence electric shock.

If heating is allowed to continue it intensifies by further increasing the local resistance through loss of temper or spring contact, formation of oxide film on contacts and wires, and leakage currents through carbonisation of insulation and tracking points. Fire can then result in the presence of combustible materials and this may release noxious fumes. Overheating may not be visually apparent. Burns may result from touching overheated components.

### 3. Handling

Care must be taken to avoid damage to any component parts of electrical connectors during installation and use. Although there are normally no sharp edges, care must be taken when handling certain components to avoid injury to fingers. Electrical connectors may be damaged in transit to customers, and damage may result in creation of hazards. Products should therefore be examined prior to installation/use and rejected if found to be damaged.

### 4. Disposal

Incineration of certain materials may release noxious or even toxic fumes.

### 5. Application

Connectors with exposed contacts should not be selected for use on the current supply side of an electrical circuit, because an electric shock could result from touching exposed contacts of an unmated connector. Voltages in excess of 30 V.A.C. or 42.5

V.D.C. are potentially hazardous and care should be taken to ensure that such voltages cannot be transmitted in any way to exposed metal parts of the connector body. The connector and wiring should be checked, before making live, to have no damage to metal parts or insulators, no solder blobs, loose strands, conducting lubricants, swarf, or any other undesired conducting particles. Circuit resistance and continuity check should be made to make certain that there are no low resistance joints or spurious conducting paths. Always use the correct application tools as specified in the Data Sheets. Do not permit untrained personnel to wire, assemble or tamper with connectors. For operation voltage please see appropriate national regulations.

### Important General Information

#### A) Air and creepage paths / Operating voltage.

The admissible operating voltages depend on the individual applications and the valid national and other applicable safety regulations. For this reason the air and creepage path data are only reference values. Observe reduction of air and creepage paths due to PC board and/or harnessing.

#### B) Other important information

Amphenol Australia Pty Ltd continuously endeavours to improve its products. Therefore, products may deviate from the description, technical data and shape as shown in product brochures.

#### C) Assembly instructions

If applicable, special assembly instructions have been included in or on the connector packaging. See also separate instructions in product brochures.